

# G GEVISS<sup>®</sup>

WINDOW & DOOR HARDWARE SYSTEMS



# G GEVISS®

## SİMGE AÇIKLAMALARI / EXPLANATION OF SYMBOLS / ОПИСАНИЕ ЗНАЧКОВ



**ÜRÜN KODU**  
PRODUCT CODE  
КОД ПРОДУКЦИИ



**PVC PROFİL UYUMLU**  
SUITABLE FOR PVC PROFILES  
СОВМЕСТИМ С ПРОФИЛЯМИ ПВХ

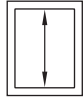

**DİKEY KULLANIM ARALIĞI**  
VERTICAL USING RANGE  
ВЕРТИКАЛЬНЫЙ ДИАПАЗОН ИСПОЛЬЗОВАНИЯ



**ALÜMİNYUM PROFİL UYUMLU**  
SUITABLE FOR ALU PROFILES  
СОВМЕСТИМ С ПРОФИЛЯМИ АЛЮМИНИЯ

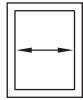

**YATAY KULLANIM ARALIĞI**  
HORIZONTAL USING RANGE  
ГОРИЗОНТАЛЬНЫЙ ДИАПАЗОН ИСПОЛЬЗОВАНИЯ



**ÜRÜN KOLİ ADETİ**  
PRODUCT QUANTITY  
КОЛИЧЕСТВО В УПАКОВКЕ



**İSPANYOLET KOL EKSENİ**  
HANDLE AXIS OF ESPAGNOLETTE  
ОСЕВОЙ ПРОМЕЖУТОК РУЧКИ



**MAKSİMUM KANAT AĞIRLIĞI**  
MAXIMUM SASH WEIGHT  
МАКСИМАЛЬНЫЙ ВЕС СТВОРКИ

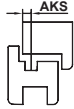

**PROFİL KİLİTLEME EKSENİ**  
PROFILE LOCKING AXIS  
ЗАПОРНЫЙ ПРОМЕЖУТОК ПРОФИЛЯ

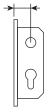

**KAPI KOL EKSENİ**  
DOOR HANDLE AXIS  
ОСЕВОЙ ПРОМЕЖУТОК ДВЕРНОЙ РУЧКИ



**KİLİT SİLİNDİR EKSENİ**  
DOOR LOCK AXIS  
ОСЕВОЙ ПРОМЕЖУТОК ЗАМКА

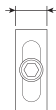

**LAMA GENİŞLİK ÖLÇÜSÜ**  
WIDTH OF ESPAGNOLETTE  
ОСНОВНОЙ РАЗМЕР ШИРИНЫ ПРИВОДА



**ÜRÜN BOY ÖLÇÜSÜ**  
PRODUCT HEIGHT  
РАЗМЕР ПРОДУКЦИИ

## INDEX

	<b>ÇİFT AÇILIM SİSTEMİ</b> / TILT AND TURN SYSTEM / ПОВОРОТНО-ОТКИДНАЯ СИСТЕМА	<b>6-23</b>
	<b>TEK AÇILIM SİSTEMİ</b> / SIDE HUNG GEAR SYSTEM / ПОВОРОТНАЯ СИСТЕМА	<b>24-29</b>
	<b>ÇİFT KANAT SİSTEMİ</b> / DOUBLE SASH SYSTEM / ДВУСТВОРЧАТАЯ СИСТЕМА	<b>30-39</b>
	<b>KAPI SİSTEMİ</b> / DOOR SYSTEM / ДВЕРНАЯ СИСТЕМА	<b>40-61</b>
	<b>VASİSTAS AÇILIM SİSTEMİ</b> / TRANSORM OPENING SYSTEM / СИСТЕМА ФРАМЖУНОГО ОТКРЫВАНИЯ	<b>62-64</b>
	<b>BASİT SÜRME SİSTEMİ</b> / SIMPLE SLIDING SYSTEM / РАЗДВИЖНАЯ СИСТЕМА ПРОСТАЯ	<b>65-72</b>
	<b>PARALEL SÜRME SİSTEMİ</b> / PARALLEL SLIDING SYSTEM / ПАРАЛЛЕЛЬНО-РАЗДВИЖНАЯ СИСТЕМА	<b>73-75</b>
	<b>AKSESUARLAR</b> / ACCESSORIES / АКЦЕССУАРЫ	<b>76-89</b>



**GEVISS** KAPI VE PENCERELERDE KULLANILAN AKSESUAR GRUPLARINI ÜRETMEK AMACI İLE 2006 YILINDA FAALİYETİNE BAŞLAMIŞTIR.

1980 YILLARINA DAYANAN İMALAT TECRÜBESİ VE BİRİKİMİ SAYESİNDE KISA SÜRE İÇERİSİNDE SEKTÖRÜNDE ÖNDE GELEN FİRMALARDAN OLMAYI BAŞARMIŞTIR.

KURULDUĞU GÜNDEN İTİBAREN İHRACATA VERDİĞİ ÖNEM SAYESİNDE BUGÜN GELİNDİĞİ NOKTADA 50'Yİ AŞAN ÜLKE İÇİN ÜRETİM YAPMAKTADIR.

İSTANBUL' DA KURULU OLAN ÜRETİM TESİSLERİNDE 26.000 m2 KAPALI ALANDA FAALİYETİNİ SÜRDÜRMEKTEDİR.

DÜNYA STANDARTLARINDA OTOMASYONA DAYALI SON TEKNOLOJİ MAKİNA PARKURUNDA ÜRETİLEN **GEVISS** ÇİFT AÇILIM SİSTEMLERİ-TEKAÇILIM VE VASİSTAS SİSTEMLERİ-SÜRME SİSTEMLERİ-KAPI KİLİTLERİ GİBİ ÜRÜN GRUPLARININ ÜRETİMİNİ GERÇEKLEŞTİRMEKTEDİR.

KONUSUNDA UZMAN MÜHENDİS VE TEKNİK ELEMAN KADROSU İLE AR-GE FAALİYETLERİNE ARALIKSIZ OLARAK DEVAM EDEN **GEVISS**, GELEN TALEPLER DOĞRULTUSUNDA ÜRÜNLERİNİN GELİŞTİRİLMESİ VE ÇEŞİTLENDİRİLMESİ NOKTASINDA ÇALIŞMALARINI DEVAM ETTİRMEKTEDİR.

KENDİ BÜNYESİNDE BULUNAN GELİŞMİŞ KALİTE LABORATUARLARI SAYESİNDE ÜRETİLEN ÜRÜNLERİN KALİTE TESLERİNİ YAPARAK SÜREKLİ SÜRDÜRÜLEBİLİR KALİTEYİ SAĞLAMAKTADIR.

---

**GEVISS** WINDOW AND DOOR ACCESORIES COMPANY HAS ESTABLISHED IN 2006.

WITH THE EXPERIENCE OF OVER 30 YEARS IN PRODUCTION, **GEVISS** SUCCEED TO BE ONE OF THE PIONEER COMPANIES IN BUSINESS. FROM **GEVISS** FACTORY WITH MORE THAN 26.000 M2 INDOOR AREA BASED IN ISTANBUL/TURKEY, WE EXPORT OUR GOODS FOR OVER 50 COUNTRIES AROUND THE WORLD.

**GEVISS** IS PRODUCING ACCESSORIES FOR PVC DOORS AND WINDOWS; WHICH ARE TILT AND TURN SYSTEMS, SLIDING SYSTEMS, DOOR LOCKS, HINGES AND ALL OTHER PRODUCTS, BY WORLD STANDARDS TECHNOLOGY AUTOMATIC BASED MACHINES. THE QUALITY OF **GEVISS** PRODUCTS IS ALWAYS UNDER CONTROL BY THE TESTS WE DO IN OUR OWN LABORATORIES.

WITH OUR EXPERIENCED TECHNICAL STAFF, ENGINEERS AND R&D DEPARTMENT, WE AIM TO KEEP OUR QUALITY HIGH AND DEVELOP OUR PRODUCT RANGE WITH THE HELP OF FEEDBACKS FROM OUR VALUABLE CUSTOMERS.

---

ПОД МАРКОЙ **GEVISS** ОКОННО И ДВЕРНУЮ ФУРНИТУРУ И АКССЕУАРЫ НАША КОМПАНИЯ НАЧАЛА ПРОИЗВОДИТЬ 2006 ГОДУ.

НАША КОМПАНИЯ NİMSAN ALUMİNYUM НАЧАЛА СВОЮ ДЕЯТЕЛЬНОСТЬ В 1980 ГОДУ, НАБРОННОЕ В ТЕЧЕНИИ ЭТОГО ВРЕМЕНИ ОПЫТУ СТАЛА ОДНИМ ИЗ ЛИДИРУЮЩИХ ФИРМ В СФЕРЕ ОКОННО ДВЕРНЫХ СИСТЕМ.

СО ДНЯ ОСНОВАНИЯ ФИРМЫ, ОСНОВНОЕ УСИЛИЕ В ПРОИЗВОДСТВЕ БЫЛО НАПРАВЛЕННО НА ЭКСПОРТ И НА ДАННЫЙ МОМЕНТ ЭКСПОРТИРУЕТ В 50 СТРАН МИРА.

ПРОИЗВОДСТВО НАХОДИТСЯ В ГОРОДЕ СТАМБУЛ, ПЛОЩАДЬЮ 26.000 м2 ЗАКРЫТЫХ ПОМЕЩЕНИЙ.

НАША ПРОДУКЦИЯ **GEVISS** ПРОИЗВОДИТСЯ ПО МИРОВЫМ СТАНДАРТАМ НА АВТОМОТИЗИРУЕМЫХ СТАНКАХ, ПРОИЗВОДЯ ПОВОРОТНО-ОТКИДНУЮ СИСТЕМУ, ПОВОРОТНУЮ СИСТЕМУ, СДВИЖНУЮ И ПАРАЛЛЕЛЬНО СДВИЖНУЮ СИСТЕМУ, ТАК ЖЕ ДВЕРНЫЕ ЗАМКИ И ДВЕРНЫЕ СИСТЕМЫ.

НАША КОМПАНИЯ В СФЕРЕ AR-GE С ОПЫТНЫМИ ИНЖЕНЕРАМИ НЕПРЕРЫВНО ПРОДОЛЖАЕТ РАЗВИВАТЬ И УЛУЧШАТЬ НАШУ ПРОДУКЦИЮ.

НАША КОМПАНИЯ ОПЕРАЯСЬ НА СВОЙ МНОГОЛЕТНИЙ ОПЫТ СОБЛЮДАЕТ ВСЕ НОРМАТИВЫ В КАЧЕСТВЕ И ТЕСТИРОВАНИЯ ПРОДУКЦИИ В ЛАБОРАТОРНЫХ УСЛОВИЯХ.



**TÜRK STANDARLARI ENSTİTÜSÜ**  
TÜRK STANDARLARINA UYGUNLUK BELGESİ  
**TURKISH STANDARDS INSTITUTION**  
CERTIFICATE OF CONFORMITY TO TURKISH STANDARDS

Makine Ticareti Bakanlığı of the Mark

TSE

**BELGE NUMARASI**  
REFERENCE NUMBER OF LICENSE: 0366796-TSE-0101

**BELGENİN İLK YERİLDİ TARİHİ**  
DATE OF FIRST ISSUE OF LICENSE: 09.08.2022

**BELGENİN SON GEÇERLİLİK TARİHİ**  
LICENSE VALID UNTIL:

**BELGE SAHİBİ KURULUŞUN ADI**  
NAME OF THE LICENSE HOLDER: HİMSAN PENCERE VE KAPI SİSTEMLERİ ANONİM ŞİRKETİ

**BELGE SAHİBİ KURULUŞUN ADRESİ**  
ADDRESS OF THE LICENSE HOLDER: ÖMERLİ MAH. RAĞIP CAD. NO:28/2 ARNAVUTKÖY İSTANBUL/TÜRKİYE

**ÜRETİM YERİ ADI**  
NAME OF THE MANUFACTURING PLACE: HİMSAN ALUMİNYUM VE PANJUR AKSESUARLARI İNŞAAT YATIRIM SANAYİ VE TİCARET LİMİTED ŞİRKETİ

**ÜRETİM YERİ ADRESİ**  
ADDRESS OF THE MANUFACTURING PLACE: ÖMERLİ MAH. RAĞIP CAD. NO:28/2 KAPI NO:2 ARNAVUTKÖY/İSTANBUL, İSTANBUL / TÜRKİYE

**İPTAL EDİLEN BELGE NUMARASI (Varsa)**  
INDICATION OF SUPERSEDED LICENSE (if any):

**TESCİLİ TİCARİ MARKASI**  
REGISTERED TRADE MARK: 364955

**İLKİLİ TÜRK STANDARDI**  
RELEVANT TURKISH STANDARD: TS EN 13126-8 / 18.11.2018

**BELGE KAPSAMI**  
SCOPE OF LICENSE:  
• KOVURMELİ VE DÖNDÜRMELİ, ÖNCE DEVRİMLEYİ VE SADECE DÖNDÜRMELİ HİRDAVAT (POZİTİF KONTROL)  
• OYUNKULUK, KALİTE H2 (10 000 CEVİRİM)  
• KÜTLE 80 KG  
• KORROZYONA DİRENÇ, KALİTE 3  
• GENEL BOYUTLAR: SRW +1 300 mm, SRH +1 200 mm

e-İMZALIYI ONAYLADIM  
09.08.2022  
Belgeleme Merkezi Başkanı Adına  
AYÇİN ÇOTEN  
TSE İSTANBUL, BELGELENDİRME MÜDÜRÜ V.

171



**Nachweis**  
Baubeschläge, Beschläge für Fenster und Fenstertüren  
gemäß EN 13126-8 : 2006

Prüfbericht  
Nr. 12-000195-PR01  
(PB-AG1-03-ce-01)

**Auftraggeber**  
Himsan Aluminium ve Panjur Ak-  
sesuarları San. Tic. Ltd. Şti.  
Habibler Mahallesi 2719  
Sokak A1, Cadde No:27  
34270 Sultangazi - İstanbul  
Türkei

**Produkt**  
Drehkipp-Beschlag für Fenster

**Bezeichnung**  
Gevis Standard  
Tit & Turn System

**Leistungswerte**  
Produktions-  
Abgelenkung (d x h): 1340 mm x 1240 mm;  
Rohmaterial: PVCU white  
Hauptfarbe: 90 kg;  
Beschlag: Tit and turn hardware, Himsan Aluminium ve  
Panjur Aks. San. Tic. Ltd. Şti.  
Beschlagung der beschriebenen Beschlagmontage:  
Körnung: KSM 720, Sauger: SM 600

**Standards**  
Klassifizierung gemäß EN 13126-8 : 2006

Ge- brauch- skategorie	Ein- baue- kategorie	Mass	Paralle- lstandig	Öff- nungs- schneid-	Konvergenz- schneid-	Schub- wirkung	Anwen- dung	Prüfplan
-	4	000	0	1	4	-	8	13001200

ift Rosenheim  
01. Juni 2012

*Andreas Maatz*  
Andreas Maatz, Dipl.-Ing. (FH)  
Qualitätsmanagement  
Bereich

*Pascal Jupp*  
Pascal Jupp, Dipl.-Ing. (FH)  
Produktmanagement  
Bereich

**Geprüft**  
Die genannten Daten und Ein-  
baueigenschaften belegen sich  
entsprechend für den Einsatz  
für beschriebenen Produkt-  
typen. Die Klassifizierung ist so-  
lange bis die Produktanwen-  
dung und die in der Beschlagung  
sich nicht geändert haben. Das  
Ergebnis kann einer Beschlagung  
entsprechender Festlegungen  
des Herstellers in Experten-  
anweisung über Prüfmuster  
überprüft werden. Diese Pro-  
zessanweisung ermöglicht bei  
den Bauelementen die erprob-  
ten Beschlag- und Beschlagungs-  
merkmaleigenschaften der ver-  
wendeten Bauelemente, nicht  
andere Merkmale, sind über-  
prüfbar werden nicht be-  
rückichtigt.  
Verpflichtungshinweise  
Es gilt die in Nummer 10  
dieser Norm beschriebene  
Prüfung mit  
Prüfmaschinen. Das  
Dokument kann als Kurzbear-  
beitung verwendet werden.  
Das Nachweise umfasst ange-  
gebene in gelten.

**ift** **DAKKS** **IAF**

**СИСТЕМА СЕРТИФИКАЦИИ ГОСТ Р**  
ФЕДЕРАЛЬНОЕ АГЕНТСТВО ПО ТЕХНИЧЕСКОМУ РЕГУЛИРОВАНИЮ И МЕТРОЛОГИИ



**СЕРТИФИКАТ СООТВЕТСТВИЯ**

№ РОСС TR.TP.08.H00794  
Срок действия с 23.09.2019 по 22.08.2022  
№ 0355695

**ОРГАН ПО СЕРТИФИКАЦИИ** д/п № RA.RU.10TR08  
продукции Общества с ограниченной ответственностью "Техническая Регламенты", Место нахождения: 121170,  
РОССИЯ, город Москва, проезд Куровской, д. 18, стр. 11, телефон +7(800)9656509, электронная почта:  
Liaison@yandex.ru, Аттестат аккредитации № RA.RU.10TR08, выдан 04.07.2016 года

**ПРОДУКЦИЯ**  
УСТРОЙСТВА ПОВОРОТНЫЕ, ПОВОРОТНО-ОТКЛЮЧАЕМЫЕ, ФУРНИТУРА И АКСЕССУАРИ  
ДЛЯ ОКОННЫХ И ДВЕРНЫХ БЛОКОВ, торговая марка GEVISS Серийный выпуск

**СООТВЕТСТВУЕТ ТРЕБОВАНИЯМ НОРМАТИВНЫХ ДОКУМЕНТОВ**  
ГОСТ 30777-2012 Устройства поворотные, откидные, поворотно-откидные, раздвижные для  
оконных и дверных блоков. Технические условия

**ИЗГОТОВИТЕЛЬ**  
HİMSAN ALUMİNYUM VE PANJUR AKSESUARLARI SANAYİ VE TİCARET LTD. ŞTİ. Место нахождения и адрес места  
осуществления деятельности: Habibler Mahallesi, A1 Cadde No:27, Sultangazi/İstanbul, TÜRKİYE, Турция

**СЕРТИФИКАТ ВЪЕЗДА**  
HİMSAN ALUMİNYUM VE PANJUR AKSESUARLARI SANAYİ VE TİCARET LTD. ŞTİ. Место нахождения и адрес места  
осуществления деятельности: Habibler Mahallesi, A1 Cadde No:27, Sultangazi/İstanbul, TÜRKİYE, Турция

**НА ОСНОВАНИИ**  
Протокола компетенции № КС000-ТН от 23.09.2019 года, выданного Испытательной лабораторией "Контроль  
Сертификация", аттестат аккредитации РОСС RU.32093.0AKCE0-005

**ДОПОЛНИТЕЛЬНАЯ ИНФОРМАЦИЯ**

С Сертификатом № 30:

Руководитель органа: *Andreas Maatz* Фредерик Оскар Борозович  
Эксперт: *Pascal Jupp* Хлыстов Денис Вячеславович

Сертификат не применяется при обязательной сертификации



**CERTIFICATE**

**HİMSAN PENCERE VE KAPI SİSTEMLERİ A.Ş.**

ÖMERLİ MAH. RAĞIP CAD. NO:28 ARNAVUTKÖY/İSTANBUL

Has implemented and maintains a Quality Management System  
MANUFACTURING AND SALES OF DOOR AND WINDOW ACCESSORIES.

EA 17,28

Through an audit, documented in a report, it was verified that the management System fulfills the  
requirements of the following standards:

**ISO 9001:2015**

Certificate registration no: QA-QTUR/9001/1307  
Valid from: 15.04.2022  
Valid until: 17.04.2023  
Date of original certification: 17.04.2020  
Certification cycle: 3 years

*S. Akbulut*  
General Operations Manager  
Region: İZMİR  
Street: 3822 BA 15

ALBERK QA TECHNIC GMBH  
Theodor Heuss Strasse 6 D-70174  
Stuttgart GERMANY  
Tel: +49 711 8654 0021 Fax: +49 711 8654 4980  
www.qa-technik.de

**IAF** **DAKKS**





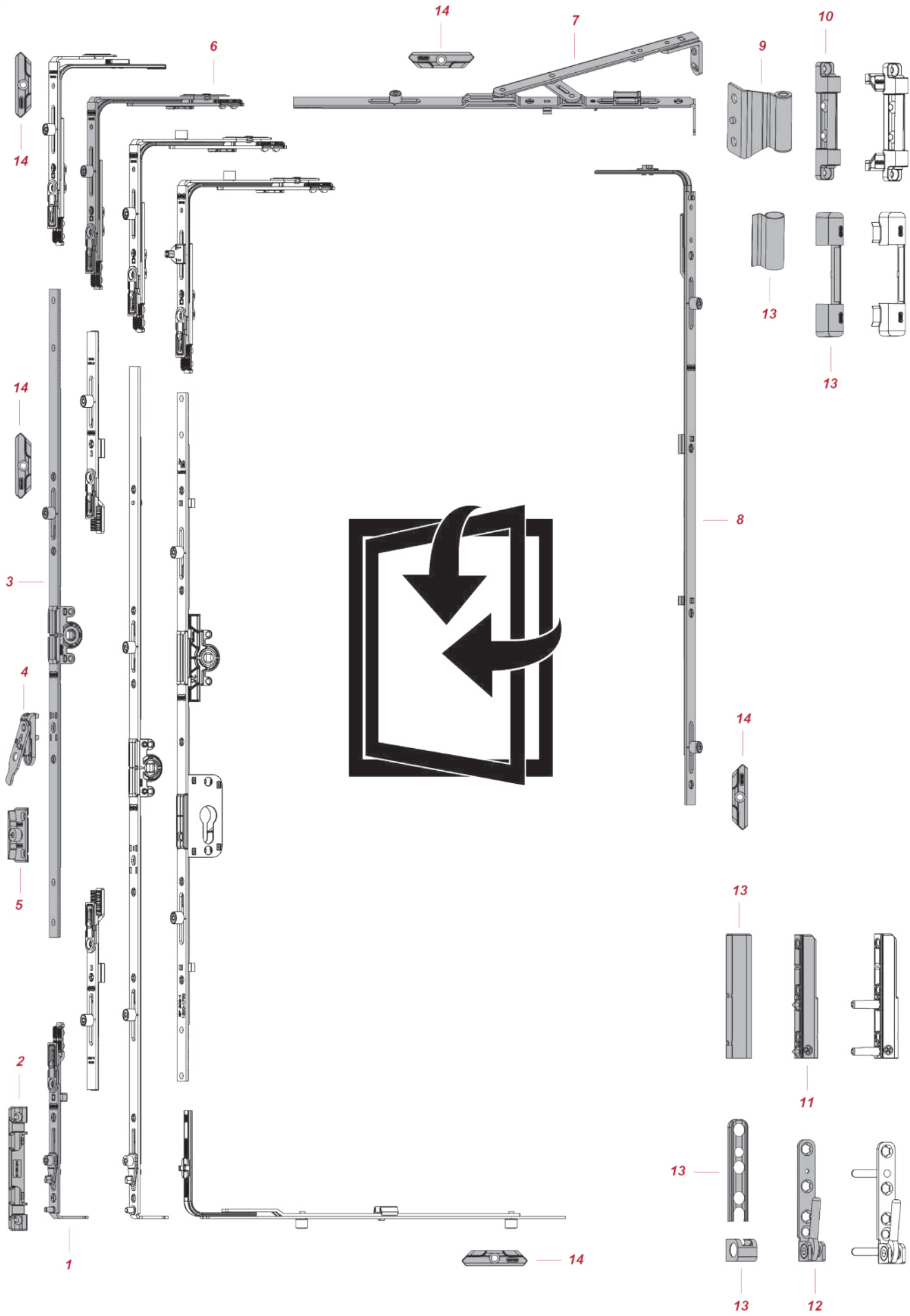



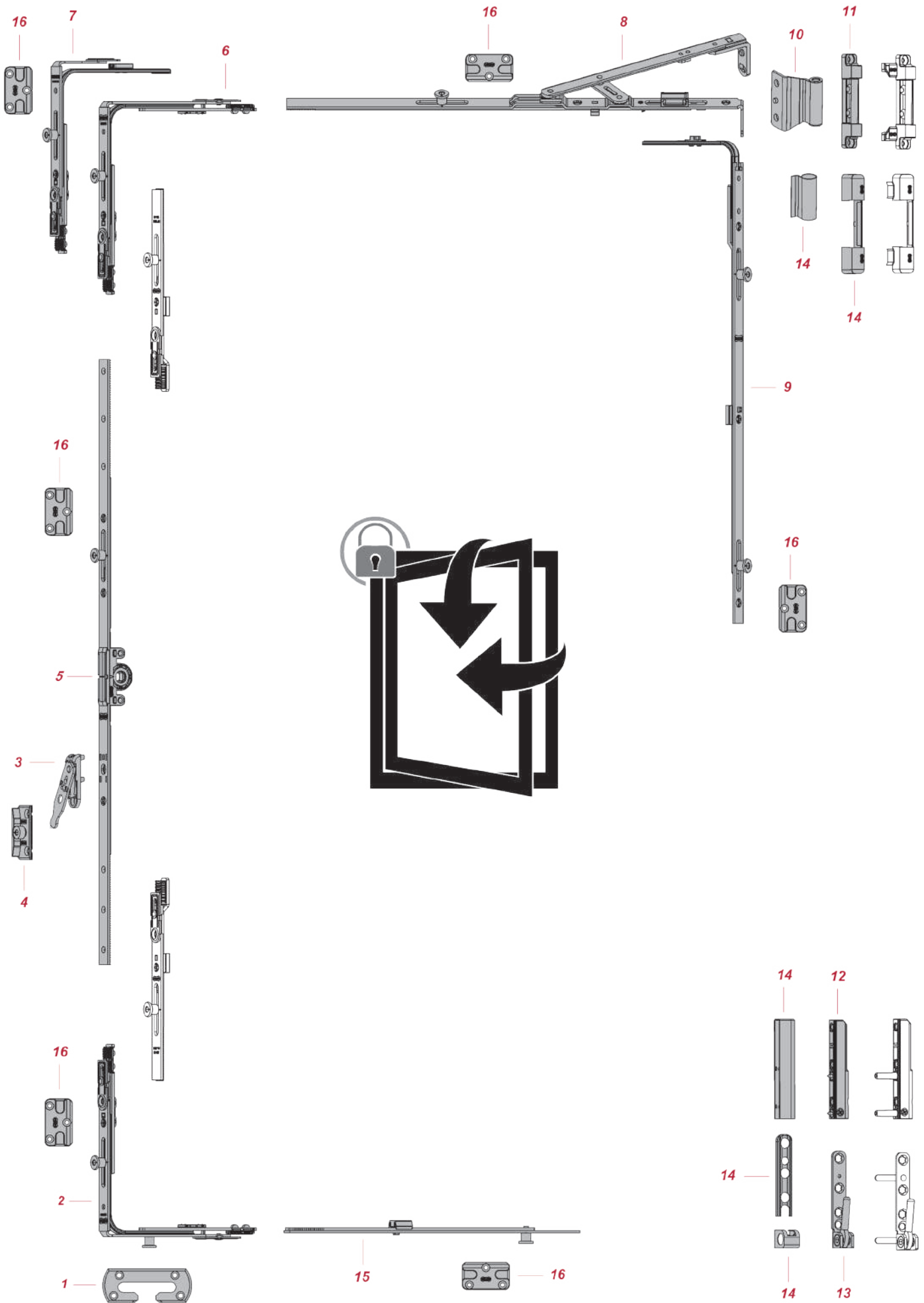

<b>NO</b>		<b>ÜRÜN ADI</b> PRODUCT NAME НАИМЕНОВАНИЕ	
1	AKH 101	<b>ALT KİLİTLEME</b> BOTTOM EXTENSION PIECE ПОВОРОТНО-ОТКИДНОЙ ФИКСАТОР	450-2450
2	AKK 220-9 AKK 200-13	<b>KARŞILIK</b> T&T LOCKING PLATE ПОВОРОТНО-ОТКИДНАЯ ПЛАНКА	9/20 mm 13 / 20 mm
3	İSP 202-1 İSP 202-1.5 İSP 202-2 İSP 202-2.5 İSP 202-3 İSP 202-4 İSP 202-5 İSP 202-6	<b>Ç.A İSPANYOLET</b> T&T ESPAGNOLETTE ПРИВОД ПОВОРОТНО-ОТКИДНОЙ	KYO-ZG 15.5 mm 450-700 570-800 700-1200 800-1300 900-1400 1200-1700 1700-2200 1950-2450
4	MSL 408	<b>MİKROLİFT</b> MICROLIFTING МИКРОЛИФТ И БЛОКИРАТОР ОШИБОЧНОГО ОТКРЫВАНИЯ	-
5	MSL - K9 MSL - K13	<b>MİKROLİFT KARŞILIĞI</b> MICROLIFTING STRIKER ОТВЕТНАЯ ПЛАНКА ПОД МИКРОЛИФТ	9/20 mm 13 / 20 mm
6	KDH 303	<b>KÖŞE DÖNÜŞ HAREKETİ</b> CORNER TRANSMISSION УГЛОВОЙ ПЕРЕКЛЮЧАТЕЛЬ	450-2450
7	MKS 404-00 MKS 404-01 MKS 404-02 MKS 404-03 MKS 404-04	<b>MAKAS</b> STAY ARM НОЖНИЦЫ	350-600 400-650 600-850 850-1100 1100-1350
8	ARK 505-0.1 ARK 505-0.2 ARK 505-1 ARK 505-1.5 ARK 505-2 ARK 505-2.5 ARK 505-3 ARK 505-4	<b>ARKA KİLİTLEME</b> MIDDLE LOCK СРЕДНИЙ ЗАПОР	-800 -800 800-1200 900-1400 1200-1700 1300-1800 1700-2200 2000-2400
9	KNM 737-9 KNM 737-13	<b>KANAT MENTEŞE</b> T&T STAY HINGES КРОНШТЕЙН ВЕРХНИЙ	9 / 20 mm 13 / 20 mm
10	KSM 720	<b>KASA MENTEŞE</b> T&T STAY ARM BEARING ПЕТЛЯ РАМЫ ВЕРХНЯЯ	-
11	HM 90-3	<b>HAREKETLİ MAFSAL - 90 mm</b> DRILL IN CORNER HINGE - 90 mm ПЕТЛЯ СТВОРКИ НИЖНЯЯ - 90 mm	100 kg
12	SM 606	<b>SABİT MAFSAL</b> CORNER BEARING ПЕТЛЯ РАМЫ НИЖНЯЯ	100 kg
13	KPT 900	<b>5'LI KARAK TAKIMI</b> COVERS КОМПЛЕКТ ПЕТЛЕВОГО ДЕКОРА	-
14	KK 350-9 KK 360-13	<b>PİM KARŞILIĞI</b> PIN STRIKER ОТВЕТНАЯ ПЛАНКА	9 / 20 mm 13 / 20 mm



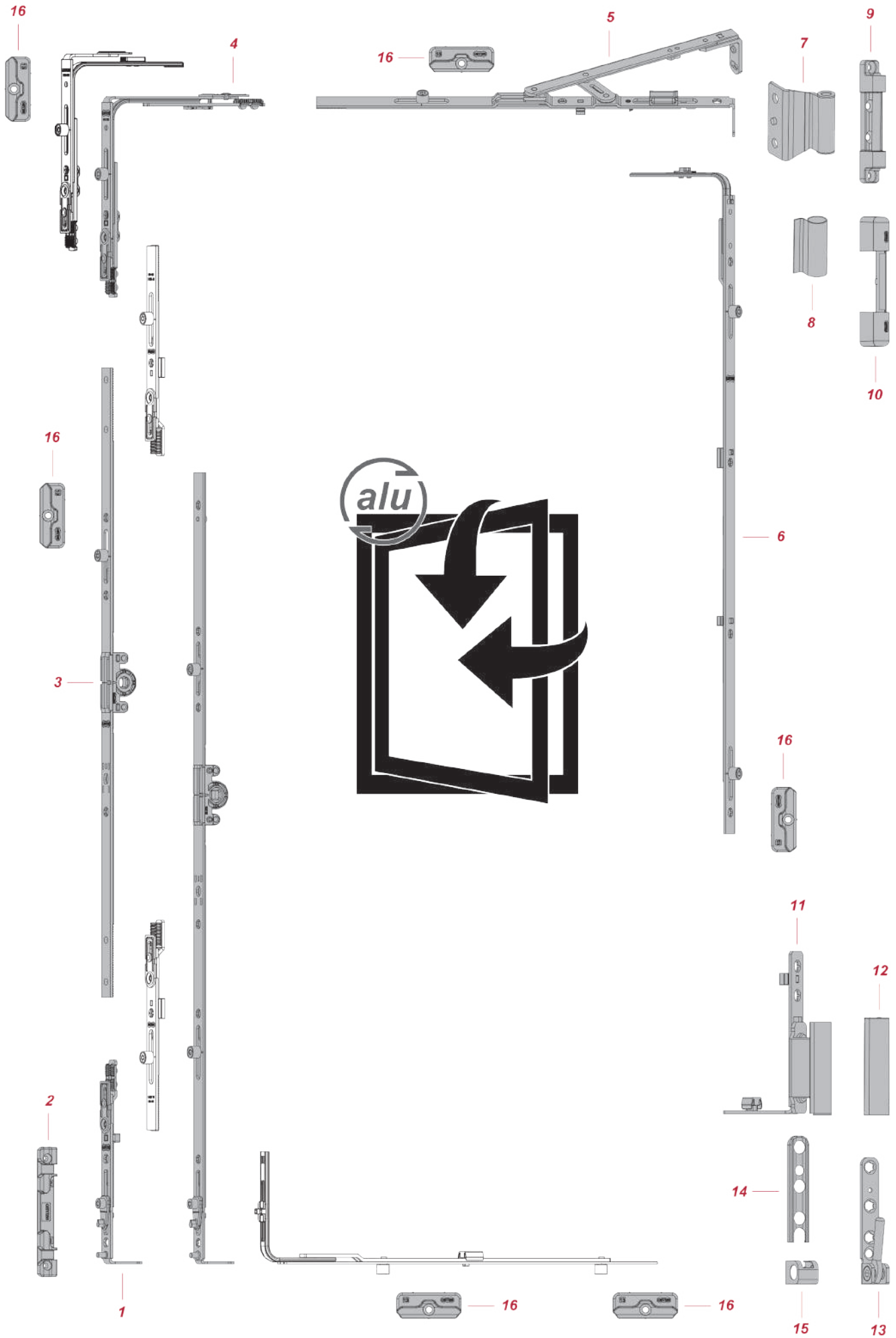

	No	ÜRÜN ADI PRODUCT NAME НАИМЕНОВАНИЕ	
1	MBK 325-9 MBK 335-13	<b>GÜVENLİKLİ KARŞILIK (YATAY DEVRİLME)</b> HORIZONTAL TILT STRIKER PLATE ПОВОРОТНО-ОТКИДНАЯ ПЛАНКА (ПРОТИВОВЗЛОМНАЯ)	9 / 20 mm 13 / 20 mm -
2	MBK 603	<b>ÇİFT TARAF MANTAR BAŞLI KÖŞE</b> CORNER TRANSMISSION WITH MUSHROOM PIN (DOUBLE PIN) УГЛОВОЙ ПЕРЕКЛЮЧАТЕЛЬ С ГРИБОВИДНЫМИ ЦАПФАМИ	450-2450
3	MSL 408	<b>MİKROLİFT</b> MICROLIFTING МИКРОЛИФТ И БЛОКИРАТОР ОШИБОЧНОГО ОТКРЫВАНИЯ	-
4	MSL - K9 MSL - K13	<b>MİKROLİFT KARŞILIĞI</b> MICROLIFTING STRIKER ОТВЕТНАЯ ПЛАНКА ПОД МИКРОЛИФТ	9 / 20 mm 13 / 20 mm -
5	İSP 202-1 İSP 202-1.5 İSP 202-G2 İSP 202-G2.5 İSP 202-G3 İSP 202-G4 İSP 202-G5 İSP 202-G6	<b>Ç.A İSPANYOLET</b> T&T ESPAGNOLETTE ПРИВОД ПОВОРОТНО-ОТКИДНОЙ	450-700 570-800 700-1200 800-1300 900-1400 1200-1700 1700-2200 1950-2450
6	MBK 703	<b>KÖŞE DÖNÜŞ HAREKETİ GÜVENLİKLİ (TEK PİMLİ)</b> SECURY CORNER TRANSMISSION [SINGLE PIN] ПЕРЕКЛЮЧАТЕЛЬ УГЛОВОЙПРОТИВОВЗЛОМНЫЙ (1 ЦАПФА)	450-2450
7	KKH 503-G	<b>KISA KÖŞE DÖNÜŞ HAREKETİ GÜVENLİKLİ</b> SECURY SHORT CORNER TRANSMISSION УГЛОВОЙ ПЕРЕКЛЮЧАТЕЛЬ КОРОТКИЙ, ПРОТИВОВЗЛОМНЫЙ	-
8	MKS 404-00 MKS 404-01 MKS 404-G02 MKS 404-G03 MKS 404-G04	<b>MAKAS</b> STAY ARM НОЖНИЦЫ	350-600 400-650 600-850 850-1100 1100-1350
9	ARK 505-G0.1 ARK 505-G0.2 ARK 505-G1 ARK 505-G1.5 ARK 505-G2 ARK 505-G2.5 ARK 505-G3 ARK 505-G4	<b>ARKA KİLİTLEME</b> MIDDLE LOCK СРЕДНИЙ ЗАПОР	-800 -800 800-1200 900-1400 1200-1700 1300-1800 1700-2200 2000-2400
10	KNM 737-9 KNM 737-13	<b>KANAT MENTEŞE</b> T&T STAY HINGES КРОНШТЕЙН ВЕРХНИЙ	9 / 20 mm 13 / 20 mm -
11	KSM 720	<b>KASA MENTEŞE</b> T&T STAY ARM BEARING ПЕТЛЯ РАМЫ ВЕРХНЯЯ	-
12	HM 90-3	<b>HAREKETLİ MAFSAL - 90 mm</b> DRILL IN CORNER HINGE - 90 mm ПЕТЛЯ СТВОРКИ НИЖНЯЯ - 90 mm	100 kg -
13	SM 606	<b>SABİT MAFSAL</b> CORNER BEARING ПЕТЛЯ РАМЫ НИЖНЯЯ	100 kg -
14	KPT 900	<b>5'LI KAPAK TAKIMI</b> COVERS КОМПЛЕКТ ПЕТЛЕВОГО ДЕКОРА	-
15	IDK 213-G1 IDK 213-G2	<b>İLAVE DÜZ KİLİTLEME</b> ADDITIONAL STRAIGHT LOCKING СРЕДНИЙ ЗАПОР ДОПОЛНИТЕЛЬНЫЙ	800-1200 1200-1700
16	GUK-9 GUK-13	<b>GÜVENLİKLİ PİM KARŞILIĞI</b> SECURY PIN STRIKER ОТВЕТНАЯ ПЛАНКА ПРОТИВОВЗЛОМНАЯ	9 / 20 mm 13 / 20 mm -

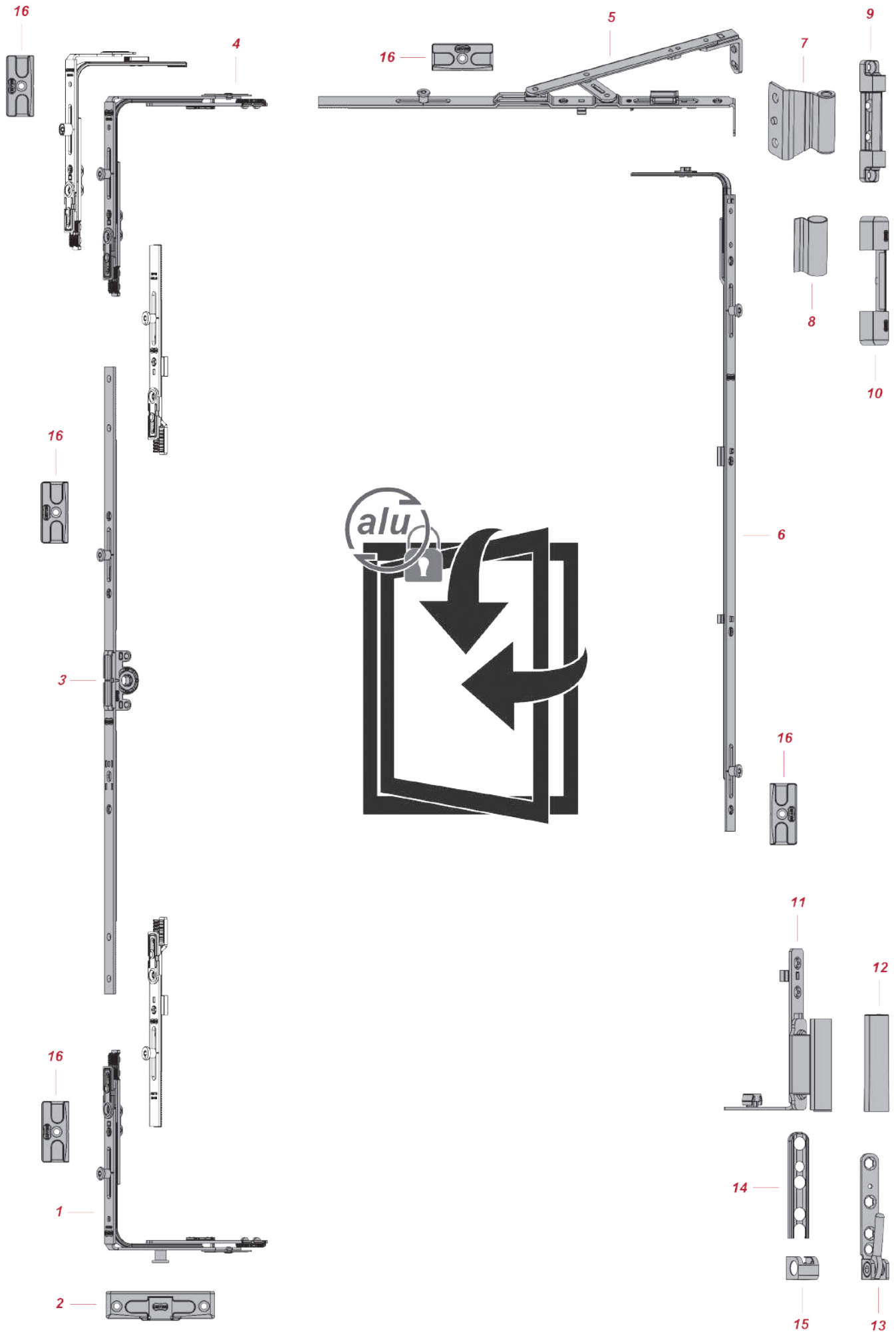

	<b>NO</b>	<b>ÜRÜN ADI</b> PRODUCT NAME НАИМЕНОВАНИЕ	
1	AKH 101	<b>ALT KİLİTLEME</b> BOTTOM EXTENSION PIECE ПОВОРОТНО-ОТКИДНОЙ ФИКСАТОР	450-2450
2	ALM-AK-9 ALM-AK-13	<b>ALÜMİNYUM ALT KİLİT KARŞILIĞI</b> ALUMINIUM T & T BOTTOM LOCKING PLATE ЗАПОРНАЯ ПЛАНКА ДЛЯ АЛЮМИНИЯ	9 / 20 mm 13 / 20 mm
3	İSP 202-1 İSP 202-1.5 İSP 202-2 İSP 202-2.5 İSP 202-3 İSP 202-4 İSP 202-5 İSP 202-6	<b>Ç.A İSPANYOLET</b> T&T ESPAGNOLETTE ПРИВОД ПОВОРОТНО-ОТКИДНОЙ	KYO-ZG 15.5 mm
4	KDH 303	<b>KÖŞE DÖNÜŞ HAREKETİ</b> CORNER TRANSMISSION УГЛОВОЙ ПЕРЕКЛЮЧАТЕЛЬ	450-2450
5	MKS 404-00 MKS 404-01 MKS 404-02 MKS 404-03 MKS 404-04	<b>MAKAS</b> STAY ARM НОЖНИЦЫ	350-600 400-650 600-850 850-1100 1100-1350
6	ARK 505-0.1 ARK 505-0.2 ARK 505-1 ARK 505-1.5 ARK 505-2 ARK 505-2.5 ARK 505-3 ARK 505-4	<b>ARKA KİLİTLEME</b> MIDDLE LOCK СРЕДНИЙ ЗАПОР	-800 -800 800-1200 900-1400 1200-1700 1300-1800 1700-2200 2000-2400
7	KNM 737-9 KNM 737-13	<b>KANAT MENTEŞE</b> T&T STAY HINGES КРОНШТЕЙН ВЕРХНИЙ	9 / 20 mm 13 / 20 mm
8	PK KNM	<b>KANAT MENTEŞE KAPAK</b> SASH HINGE COVER ДЕКОР НАКЛАДКА ВЕРХНЕГО КРОНШТЕЙНА	-
9	KSM 720	<b>KASA MENTEŞE</b> T&T STAY ARM BEARING ПЕТЛЯ РАМЫ ВЕРХНЯЯ	-
10	PK KSMN	<b>KASA MENTEŞE KAPAK</b> FRAME HINGE COVER ДЕКОР НАКЛАДКА ВЕРХНЕЙ ПЕТЛИ РАМЫ	-
11	AHM 207/R AHM 207/L	<b>AYARLI HAREKETLİ MAFSAL</b> ADJUSTABLE DRILL IN CORNER HINGE ПЕТЛЯ УНИВЕРСАЛЬНАЯ (С РЕГУЛИРОВКОЙ)	9 / 20 mm 13 / 20 mm
12	KPT 700/R KPT 700/L	<b>AYARLI HAREKETLİ MAFSAL KAPAK</b> ADJUSTABLE DRILL IN CORNER HINGE COVER ДЕКОР УНИВЕРСАЛЬНОЙ (С РЕГУЛИРОВКОЙ)	-
13	SM 606	<b>SABİT MAFSAL</b> CORNER BEARING ПЕТЛЯ РАМЫ НИЖНЯЯ	100 kg
14	PK SMU	<b>SABİT MAFSAL UZUN KAPAK</b> CORNER BEARING COVER - LONG TYPE ДЕКОР НАКЛАДКА НИЖНЕЙ ПЕТЛИ РАМЫ (ДЛИННЫЙ)	-
15	PK SMK	<b>SABİT MAFSAL KISA KAPAK</b> CORNER BEARING COVER - SHORT TYPE ДЕКОР НАКЛАДКА НИЖНЕЙ ПЕТЛИ РАМЫ (МАЛЫЙ)	-
16	ALM-K9 ALM-K13	<b>ALÜMİNYUM PİM KARŞILIĞI</b> ALUMINIUM PIN STRIKER ОТВЕТНАЯ ПЛАНКА ДЛЯ АЛЮМИНИЯ	9 / 20 mm 13 / 20 mm



		<b>ÜRÜN ADI</b> <b>PRODUCT NAME</b> <b>НАИМЕНОВАНИЕ</b>	
1	MBK 603	<b>ÇİFT TARAF MANTAR BAŞLI KÖŞE</b> CORNER TRANSMISSION WITH MUSHROOM PIN (DOUBLE PIN) УГЛОВОЙ ПЕРЕКЛЮЧАТЕЛЬ С ГРИБОВИДНЫМИ ЦАПФАМИ	450-2450
2	YUN-AK-01	<b>ALT DEVRİLME KARŞILIK-ALÜMİNYUM PROFİL İÇİN</b> T & T LOCKING PLATE-FOR ALUMINIUM PROFILES ЗАПОРНАЯ ПЛАНКА ГРИБОВИДНОЙ ЦАПФЫ ДЛЯ АЛЮМИНИЕВЫХ ПРОФИЛЕЙ	9/20 mm
3	İSP 202-1 İSP 202-1.5 İSP 202-G2 İSP 202-G2.5 İSP 202-G3 İSP 202-G4 İSP 202-G5 İSP 202-G6	<b>Ç.A İSPANYOLET</b> T&T ESPAGNOLETTE ПРИВОД ПОВОРОТНО-ОТКИДНОЙ	KYO-ZG 15.5 mm
4	MBK 703	<b>MANTAR BAŞLI KÖŞE</b> MUSHROOM PIN TYPE CORNER УГОЛ С ГРИБОВИДНОЙ ЦАПФОЙ	450-2450
5	MKS 404-00 MKS 404-01 MKS 404-G2 MKS 404-G3 MKS 404-G4	<b>MAKAS</b> STAY ARM НОЖНИЦЫ	350-600 400-650 600-850 850-1100 1100-1350
6	ARK 505-G0.1 ARK 505-G0.2 ARK 505-G1 ARK 505-G1.5 ARK 505-G2 ARK 505-G2.5 ARK 505-G3 ARK 505-G4	<b>ARKA KİLİTLEME</b> MIDDLE LOCK СРЕДНИЙ ЗАПОР	-800 -800 800-1200 900-1400 1200-1700 1300-1800 1700-2200 2000-2400
7	KNM 737-9	<b>KANAT MENTEŞE</b> T&T STAY HINGES КРОНШТЕЙН ВЕРХНИЙ	9 / 20 mm
8	PK KNM	<b>KANAT MENTEŞE KAPAK</b> SASH HINGE COVER ДЕКОР НАКЛАДКА ВЕРХНЕГО КРОНШТЕЙНА	-
9	KSM 720	<b>KASA MENTEŞE</b> T&T STAY ARM BEARING ПЕТЛЯ РАМЫ ВЕРХНЯЯ	-
10	PK KSMN	<b>KASA MENTEŞE KAPAK</b> FRAME HINGE COVER ДЕКОР НАКЛАДКА ВЕРХНЕЙ ПЕТЛИ РАМЫ	-
11	AHM 207 - 9R AHM 207 - 9L	<b>AYARLI HAREKETLİ MAFSAL</b> ADJUSTABLE DRILL IN CORNER HINGE ПЕТЛЯ УНИВЕРСАЛЬНАЯ (С РЕГУЛИРОВКОЙ)	9 / 20 mm
12	KPT 700/R KPT 700/L	<b>AYARLI HAREKETLİ MAFSAL KAPAK</b> ADJUSTABLE DRILL IN CORNER HINGE COVER ДЕКОР УНИВЕРСАЛЬНОЙ (С РЕГУЛИРОВКОЙ)	-
13	SM 606	<b>SABİT MAFSAL</b> CORNER BEARING ПЕТЛЯ РАМЫ НИЖНЯЯ	100 kg
14	PK SMU	<b>SABİT MAFSAL UZUN KAPAK</b> CORNER BEARING COVER - LONG TYPE ДЕКОР НАКЛАДКА НИЖНЕЙ ПЕТЛИ РАМЫ (ДЛИННЫЙ)	-
15	PK SMK	<b>SABİT MAFSAL KISA KAPAK</b> CORNER BEARING COVER - SHORT TYPE ДЕКОР НАКЛАДКА НИЖНЕЙ ПЕТЛИ РАМЫ (МАЛЫЙ)	-
16	YUN-PK-02	<b>MANTAR BAŞLI PİM KARŞILIĞI-ALÜMİNYUM PROFİLLER İÇİN</b> SECURY PIVOT STRIKER-FOR ALUMINIUM PROFILER ОТВЕТНАЯ ПЛАНКА ГРИБОВИДНОЙ ЦАПФЫ ДЛЯ АЛЮМИНИЕВЫХ ПРОФИЛЕЙ	9 / 20 mm

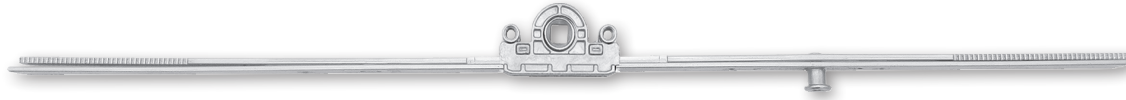

A NO	B NO	ÇİFT AÇILIM İSPANYOLET TILT & TURN ESPAGNOLETTE ПРИВОД ПОВОРОТНО ОТКИДНОЙ			
İSP 202-1	-		15.5	450-700	10
İSP 202-1,5	-		15.5	570-800	10
İSP 202-2	İSP 202-G2		15.5	700-1200	10
İSP 202-2.5	İSP 202-G2.5		15.5	800-1300	10
İSP 202-3	İSP 202-G3		15.5	900-1400	10
İSP 202-4	İSP 202-G4		15.5	1200-1700	10
İSP 202-5	İSP 202-G5		15.5	1700-2200	10
İSP 202-6	İSP 202-G6		15.5	1950-2450	10



A NO	B NO	ÇİFT AÇILIM İSPANYOLET TILT & TURN ESPAGNOLETTE ПРИВОД ПОВОРОТНО ОТКИДНОЙ			
İSP 202-1/7.5	-		7.5	445-695	20
İSP 202-1,5/7.5	-		7.5	565-795	20
İSP 202-2/7.5	İSP 202-G2/7.5		7.5	695-1195	20
İSP 202-2.5/7.5	İSP 202-G2.5/7.5		7.5	795-1295	20
İSP 202-3/7.5	İSP 202-G3/7.5		7.5	895-1395	20
İSP 202-4/7.5	İSP 202-G4/7.5		7.5	1195-1695	20
İSP 202-5/7.5	İSP 202-G5/7.5		7.5	1695-2195	20
İSP 202-6/7.5	İSP 202-G6/7.5		7.5	1945-2445	20

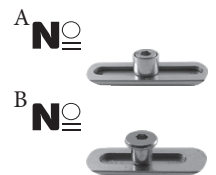
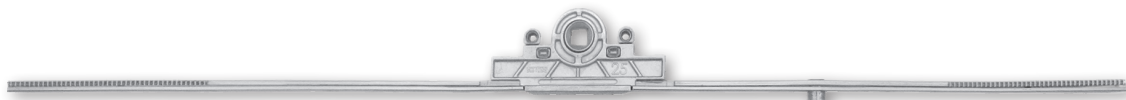

A NO	B NO	ÇİFT AÇILIM İSPANYOLET TILT & TURN ESPAGNOLETTE ПРИВОД ПОВОРОТНО ОТКИДНОЙ			
İSP 202-1/25	-		25	450-700	15
İSP 202-1,5/25	-		25	570-800	15
İSP 202-2/25	İSP 202-G2/25		25	700-1200	15
İSP 202-2.5/25	İSP 202-G2.5/25		25	800-1300	15
İSP 202-3/25	İSP 202-G3/25		25	900-1400	15
İSP 202-4/25	İSP 202-G4/25		25	1200-1700	15
İSP 202-5/25	İSP 202-G5/25		25	1700-2200	15
İSP 202-6/25	İSP 202-G6/25		25	1950-2450	15



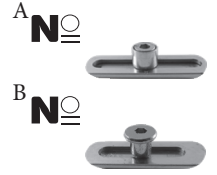
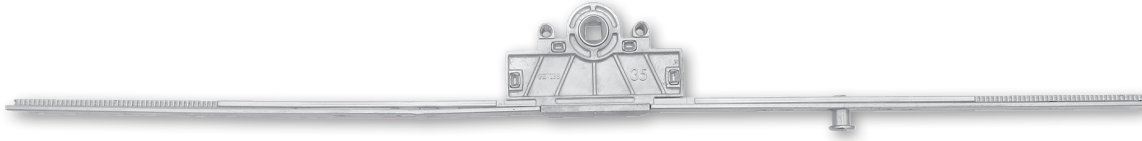

A NO	B NO	ÇİFT AÇILIM İSPANYOLET TILT & TURN ESPAGNOLETTE ПРИВОД ПОВОРОТНО ОТКИДНОЙ			
İSP 202-1/35	-		35	450-700	10
İSP 202-1,5/35	-		35	570-800	10
İSP 202-2/35	İSP 202-G2/35		35	700-1200	10
İSP 202-2,5/35	İSP 202-G2.5/35		35	800-1300	10
İSP 202-3/35	İSP 202-G3/35		35	900-1400	10
İSP 202-4/35	İSP 202-G4/35		35	1200-1700	10
İSP 202-5/35	İSP 202-G5/35		35	1700-2200	10
İSP 202-6/35	İSP 202-G6/35		35	1950-2450	10

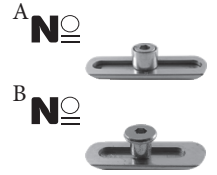

A NO	B NO	ÇİFT AÇILIM İSPANYOLET - KOL YERİ SABİT TILT & TURN ESPAGNOLETTE - FIXED HANDLE PLACE ПРИВОД (РУЧКА КОНСТАНТНАЯ)			
KYS-S01	-		15.5	400-650	10
KYS-S02	-		15.5	620-870	10
KYS-S03	KYS-G01		15.5	850-1100	10
KYS-S04	KYS-G02		15.5	1000-1250	10
KYS-S05	KYS-G03		15.5	1250-1500	10
KYS-S06	KYS-G04		15.5	1500-1750	10
KYS-S07	KYS-G05		15.5	1600-1850	10
KYS-S08	KYS-G06		15.5	1750-2000	10
KYS-S09	KYS-G07		15.5	2000-2250	10

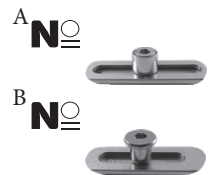

A NO	B NO	ÇİFT AÇILIM İSPANYOLET BAREL KİLİTLEMELİ TILT & TURN GEAR FOR CYLINDER LOCKING ПРИВОД ПОВОРОТНО-ОТКИДНОЙ ПОД ЦИЛИНДР			
CA 25-BRL/2.5	CA 25-BRL/G2.5		25	800-1300	10
CA 25-BRL/3	CA 25-BRL/G3		25	900-1400	10
CA 25-BRL/4	CA 25-BRL/G4		25	1200-1700	10
CA 25-BRL/5	CA 25-BRL/G5		25	1700-2200	10
CA 25-BRL/6	CA 25-BRL/G6		25	1950-2450	10

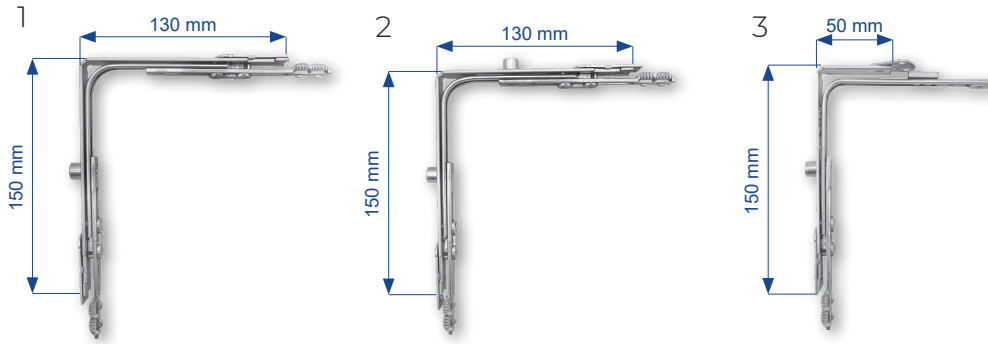

	<b>N<sub>O</sub></b>	<b>KÖŞE DÖNÜŞ HAREKETİ</b> CORNER TRANSMISSION УГЛОВОЙ ПЕРЕКЛЮЧАТЕЛЬ			
1	KDH 303		350-1350	450-2450	50
2	KDH 303-1		350-1350	450-2450	50
3	KKH 503		280-1350	450-2450	50

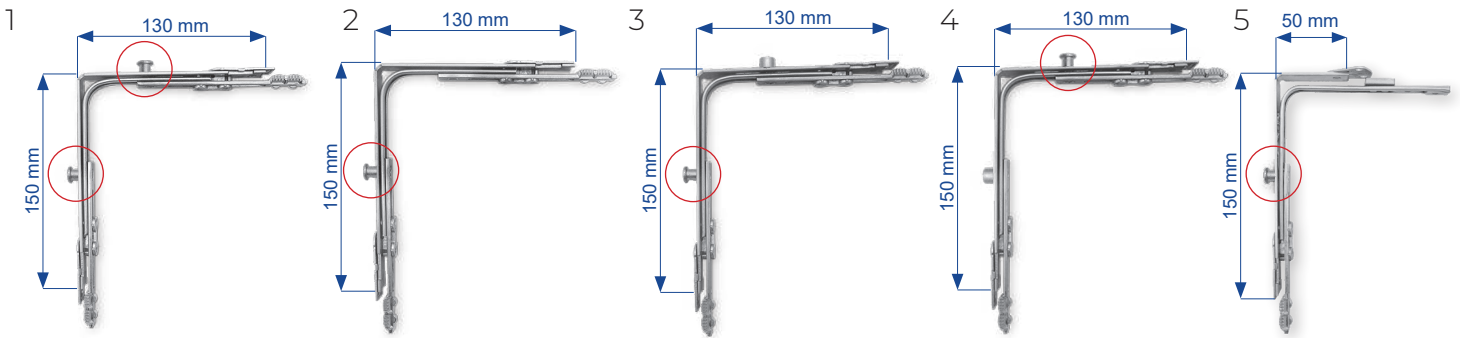

	<b>N<sub>O</sub></b>	<b>MANTAR BAŞLI KÖŞE</b> MUSHROOM PIN TYPE CORNER УГОЛ С ГРИБОВИДНОЙ ЦАПФОЙ			
1	MBK 603		350-1350	450-2450	50
2	MBK 703		350-1350	450-2450	50
3	MBK 803		350-1350	450-2450	50
4	MBK 903		350-1350	450-2450	50
5	KKH 503-G		280-1350	450-2450	50

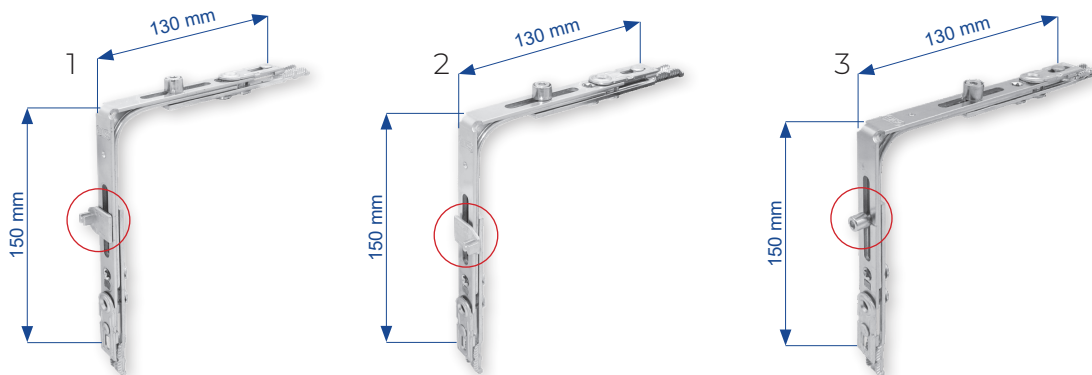

	<b>A N<sub>O</sub></b>	<b>B N<sub>O</sub></b>	<b>MİKROVENTİLASYON KÖŞELER</b> MICROVENTILATION CORNERS УГЛОВЫЕ ПЕРЕКЛЮЧАТЕЛИ ДЛЯ МИКРОПРОВЕТРИВАНИЯ			
1	AHK 912/R	AHK 912-G/R		350-1350	450-2450	50
2	AHK 912/L	AHK 912-G/L		350-1350	450-2450	50
3	GHK 322	GHK 322-G		350-1350	450-2450	50



A NO	B NO	ÇİFT AÇILIM MAKAS TILT & TURN STAY ARM НОЖНИЦЫ		
MKS 404-00	-		350-600	10
MKS 404-01	-		400-650	10
MKS 404-02	MKS 404-G2		600-850	10
MKS 404-03	MKS 404-G3		850-1100	10
MKS 404-04	MKS 404-G4		1100-1350	10

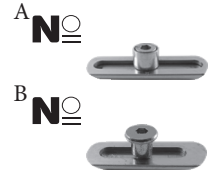

A NO	B NO	ARKA KİLİTLEME MIDDLE LOCK СРЕДНИЙ ЗАПОР		
ARK 505-0.1	ARK 505-G0.1		-800	10
ARK 505-0.2	ARK 505-G0.2		-800	10
ARK 505-1	ARK 505-G1		800-1200	10
ARK 505-1.5	ARK 505-G1.5		900-1400	10
ARK 505-2	ARK 505-G2		1200-1700	10
ARK 505-2.5	ARK 505-G2.5		1300-1800	10
ARK 505-3	ARK 505-G3		1700-2200	10
ARK 505-4	ARK 505-G4		2000-2400	10



	N NO	ÇİFT AÇILIM HATALI KULLANIM ENGELLEYİCİLER TILT & TURN FAULTY USAGE PREVENTERS БЛОКИРАТОРЫ ОШИБОЧНОГО ИСПОЛЬЗОВАНИЯ РУЧКИ	
1	MSL 408		100
2	HKD-01		100

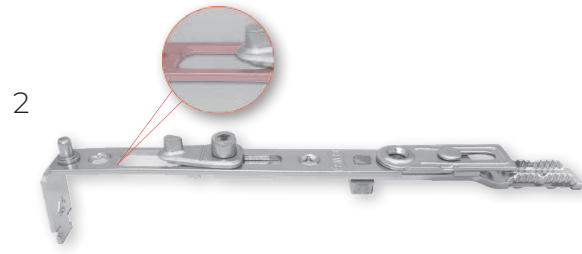
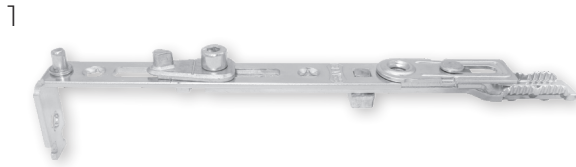

<b>NO</b>		<b>ALT KİLİLEME</b> BOTTOM EXTENSION PIECE ПОВОРОТНО-ОТКИДНОЙ ФИКСАТОР		
1	AKH 101		450-2450	50
2	AKH 101-1		450-2450	50

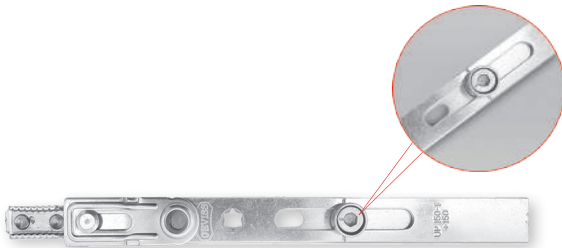

<b>A NO</b>	<b>B NO</b>	<b>UZATMA PARÇASI - PİMLİ</b> EXTENSION PART - PINNED УДЛИНИТЕЛЬ ЗАПОРНЫЙ С ЦАПФОЙ		
UP 150-1	UP 150-G1		+150	50
UP 150-2	UP 150-G2		+400	15
UP 200-1	UP 200-G1		+190	50

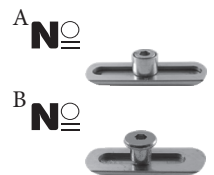

<b>A NO</b>	<b>B NO</b>	<b>İLAVE DÜZ KİLİLEME</b> ADDITIONAL STRAIGHT LOCKING СРЕДНИЙ ЗАПОР ДОПОЛНИТЕЛЬНЫЙ		
IDK 213-1	IDK 213-G1		800-1200	10
IDK 213-2	IDK 213-G2		1200-1700	10



	<b>NO</b>	<b>KASA MENTEŞE</b> T&T STAY ARM BEARING ПЕТЛЯ РАМЫ ВЕРХНЯЯ	<b>KG</b>	
1	KSM 720	3 mm	100	100
2	KSM 730		100	100
3	KSM 740	6 mm	100	100



	<b>NO</b>	<b>KANAT MENTEŞE</b> T&T STAY HINGES КРОНШТЕЙН ВЕРХНИЙ		<b>KG</b>	
1	KNM 737-9		9	100	100
2	KNM 737-13		13	100	100

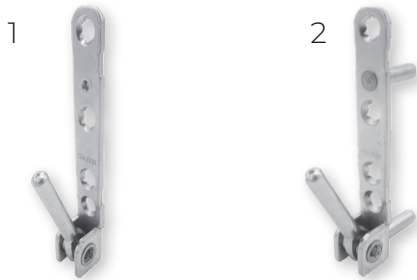

	<b>NO</b>	<b>SABİT MAFSAL</b> CORNER BEARING ПЕТЛЯ РАМЫ НИЖНЯЯ	<b>KG</b>	
1	SM 606		100	100
2	SM 606-1		130	100



	<b>NO</b>	<b>HAREKETLİ MAFSAL</b> DRILL IN CORNER HINGE ПЕТЛЯ СТВОРКИ НИЖНЯЯ	<b>KG</b>	
1	HM 90-3		100	100
2	HM 90-6		130	100

A **N** 

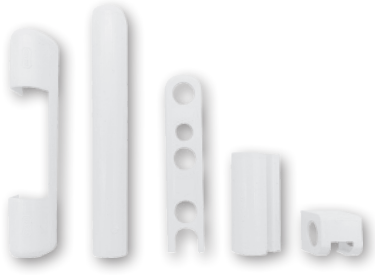

B **N** 



A <b>N</b>	B <b>N</b>	5' Lİ KAPAK TAKIMI COVERS КОМПЛЕКТ ПЕТЛЕВОГО ДЕКОРА	RENK COLOR ЦВЕТ	
KPT 900-1	KPT 800-1		BEYAZ / WHITE / БЕЛЫЙ RAL 9016	100
KPT 900-2	KPT 800-2		ALTINMEŞE / GOLDEN OAK / ЗОЛОТОЙ ДУБ RAL 8003	100
KPT 900-3	KPT 800-3		KOYU KAHVE / DARK BROWN / ТЁМНОКОРИЧНЕВЫЙ RAL 8019	100
KPT 900-4	KPT 800-4		SİYAH / BLACK / ЧЕРНЫЙ	100
KPT 900-5	KPT 800-5		GRİ / GREY / СЕРЫЙ	100
KPT 900-6	KPT 800-6		ÖZEL RENK / PRIVATE COLOR / ЦВЕТ НА ЗАКАЗ	100

A **N** 



B **N** 



C **N** 



A <b>N</b>	B <b>N</b>	C <b>N</b>	MENTEŞE KAPAKLARI HINGE COVERS ПЕТЛЕВОЙ ДЕКОР	RENK COLOR ЦВЕТ	
PK KSMN 01	PK KSMS 01	PK HMA 01		BEYAZ / WHITE / БЕЛЫЙ	100
PK KSMN 02	PK KSMS 02	PK HMA 02		ALTINMEŞE / GOLDEN OAK / СВЕТЛОКОРИЧНЕВЫЙ	100
PK KSMN 03	PK KSMS 03	PK HMA 03		KOYU KAHVE / DARK BROWN / ТЁМНОКОРИЧНЕВЫЙ	100
PK KSMN 04	PK KSMS 04	PK HMA 04		SİYAH / BLACK / ЧЕРНЫЙ	100
PK KSMN 05	PK KSMS 05	PK HMA 05		GRİ / GREY / СЕРЫЙ	100
PK KSMN 06	PK KSMS 06	PK HMA 06		ÖZEL RENK / PRIVATE COLOR / ЦВЕТ НА ЗАКАЗ	100

A **N** 



B **N** 





C **N** 

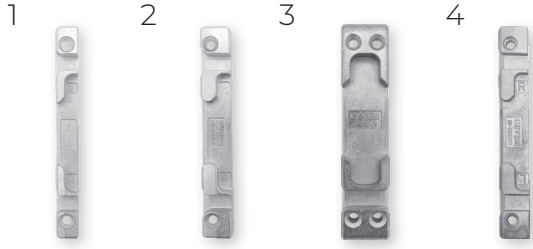

A <b>N</b>	B <b>N</b>	C <b>N</b>	MENTEŞE KAPAKLARI HINGE COVERS ПЕТЛЕВОЙ ДЕКОР	RENK COLOR ЦВЕТ	
PK SMU 01	PK KNM 01	PK SMK 01		BEYAZ / WHITE / БЕЛЫЙ	100
PK SMU 02	PK KNM 02	PK SMK 02		ALTINMEŞE / GOLDEN OAK / СВЕТЛОКОРИЧНЕВЫЙ	100
PK SMU 03	PK KNM 03	PK SMK 03		KOYU KAHVE / DARK BROWN / ТЁМНОКОРИЧНЕВЫЙ	100
PK SMU 04	PK KNM 04	PK SMK 04		SİYAH / BLACK / ЧЕРНЫЙ	100
PK SMU 05	PK KNM 05	PK SMK 05		GRİ / GREY / СЕРЫЙ	100
PK SMU 06	PK KNM 06	PK SMK 06		ÖZEL RENK / PRIVATE COLOR / ЦВЕТ НА ЗАКАЗ	100



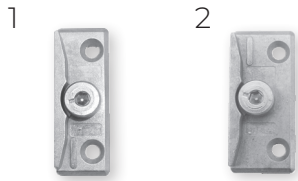

	<b>NO</b>	<b>DİKEY DEVRİLME KARŞILIĞI</b> VERTICAL TILT STRIKER ЗАПОРНЫЕ ПЛАНКИ		
1	AKK 220-9		9	100
2	AKK 200-13		13	100
3	AKK 230-9		9	100
4	AKK 205-12		12	100



	<b>NO</b>	<b>MİKROLİFT KARŞILIK</b> MICROLIFTING STRIKER ОТВЕТНАЯ ПЛАНКА		
1	MSL-K9		9	100
2	MSL-K13		13	100





	<b>NO</b>	<b>İSPANYOLET PİM KARŞILIĞI</b> ESPAÑOLETE PIVOT STRIKER ОТВЕТНЫЕ ПЛАНКИ		
1	KK 350-9		9	1000
2	KK 350-10		10	1000
3	KK 360-13		13	1000
4	KK P6000-12		12	1000
5	KK 360-14		14	1000
6	KK 360-S13		13	1000
7	KK 360-S13-G		13	1000
8	KK P4500-12		12	1000
9	CMK 22-AKS		22	1000

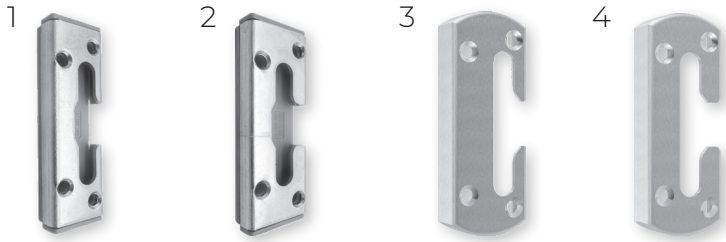

NO		PLASTİK İSPANYOLET PİM KARŞILIĞI PLASTIC ESPAGNOLETTE STRIKER ПЛАСТИКОВАЯ ОТВЕТНАЯ ПЛАНКА		
1	PLS KK-9		9	100
2	PLS KK-13		13	100



NO		GÜVENLİKLİ YATAY DEVRİLME KARŞILIĞI CORNER TRANSMISSION SECURITY PIN STRIKER ОТВЕТНЫЕ ПЛАНКИ ДЛЯ ГРИБОВИДНОЙ ЦАПФЫ		
1	MBK 320-9		9	100
2	MBK 330-13		13	100
3	MBK 325-9		9	100
4	MBK 335-13		13	100

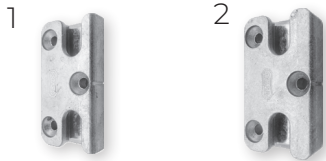

NO		GÜVENLİKLİ PİM KARŞILIĞI SECURITY PIN STRIKER ОТВЕТНАЯ ПЛАНКА ПРОТИВОВЗЛОМНАЯ		
1	GUK-9		9	100
2	GUK-13		13	100

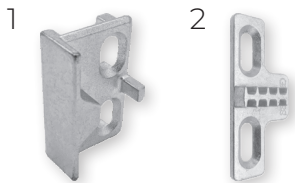

NO		MİKROVENTİLASYON KARŞILIĞI MICROVENTILATION STRIKER ОТВЕТКИ МИКРОВЕНТИЛЯЦИИ		
1	GHK P100		-	100
2	AHK 913		-	100



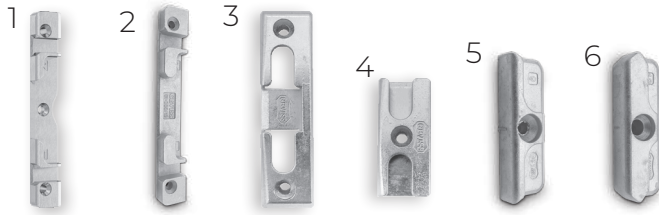

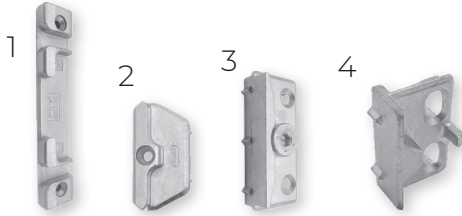

	<b>N<sub>0</sub></b>	ALÜMİNYUM PROFİLLERE ÖZEL KARŞILIKLAR SPECIAL STRIKERS FOR ALUMINIUM PROFILES ОТВЕТНЫЕ ПЛАНКИ ДЛЯ АЛЮМИНИЕВЫХ ПРОФИЛЕЙ		
1	ALM-AK-9		9	100
2	ALM-AK-13		13	100
3	YUN-AK-01	<b>GÜVENLİKLİ PİM UYUMLU</b> / SUITABLE FOR SECURITY PIN / ОТВЕТНЫЕ ПЛАНКИ ДЛЯ ГРИБОВИДНОЙ ЦАПФЫ	9	100
4	YUN-PK-02	<b>GÜVENLİKLİ PİM UYUMLU</b> / SUITABLE FOR SECURITY PIN / ОТВЕТНЫЕ ПЛАНКИ ДЛЯ ГРИБОВИДНОЙ ЦАПФЫ	9	100
5	ALM-K9		9	100
6	ALM-K13		13	100

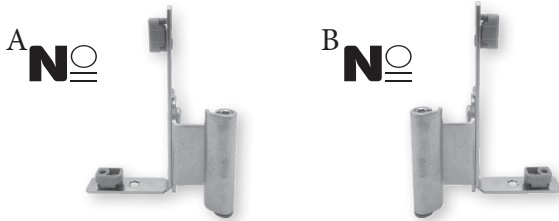

	<b>N<sub>0</sub></b>	GENİŞ KANAL PROFİLLERE ÖZEL KARŞILIKLAR SPECIAL FOR WIDE CHANNEL PROFILES STRIKERS ОТВЕТНЫЕ ПЛАНКИ ДЛЯ ПРОФИЛЕЙ С ШИРОКИМ ПАЗОМ		
1	CTK-12/AK		12	100
2	CTK-12/KK		12	500
3	CTK-12/MSLK		12	100
4	GHK P200		-	100



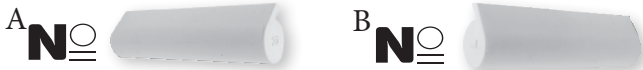

<b>A</b>	<b>B</b>	<b>N<sub>0</sub></b>	AYARLI HAREKETLİ MAFSAL ADJUSTABLE DRILL IN CORNER HINGE ПЕТЛЯ УНИВЕРСАЛЬНАЯ (С РЕГУЛИРОВКОЙ)		
AHM 207-9R	AHM 207-9L			9	50
AHM 207-13R	AHM 207-13L			13	50

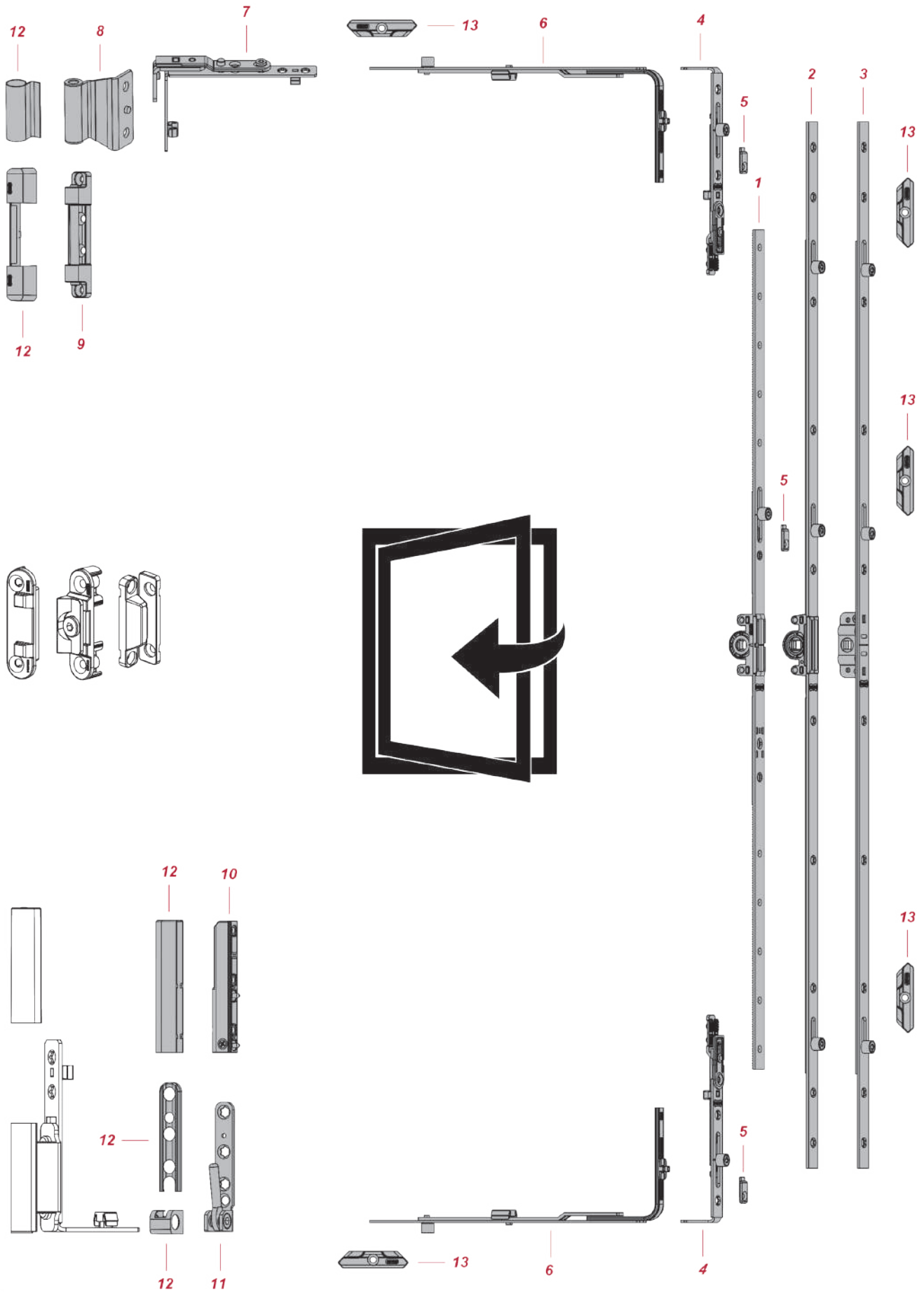

<b>A</b>	<b>B</b>	<b>N<sub>0</sub></b>	AYARLI HAREKETLİ MAFSAL KAPAK ADJUSTABLE DRILL IN CORNER HINGE COVER ДЕКОР УНИВЕРСАЛЬНОЙ (С РЕГУЛИРОВКОЙ)	RENK COLOR ЦВЕТ	
KPT 700-1/R	KPT 700-1/L			BEYAZ / WHITE / БЕЛЫЙ	100
KPT 700-2/R	KPT 700-2/L			ALTINMEŞE (DESENLİ) / GOLDEN OAK (PATTERNED) / ЗОЛОТОЙ ДУБ	100
KPT 700-3/R	KPT 700-3/L			KOYU KAHVE / DARK BROWN / ТЕМНОКОРИЧНЕВЫЙ	100
KPT 700-4/R	KPT 700-4/L			SİYAH / BLACK / ЧЕРНЫЙ	100
KPT 700-5/R	KPT 700-5/L			GRİ / GREY / СЕРЫЙ	100
KPT 700-6/R	KPT 700-6/L			ÖZEL RENK / PRIVATE COLOR / ЦВЕТ НА ЗАКАЗ	100



		<b>ÜRÜN ADI</b> <b>PRODUCT NAME</b> <b>НАИМЕНОВАНИЕ</b>	
1	İSP 202-1 İSP 202-1.5 İSP 202-2 İSP 202-2.5 İSP 202-3 İSP 202-4 İSP 202-5 İSP 202-6	<b>Ç.A İSPANYOLET</b> <b>T&amp;T ESPAGNOLETTE</b> <b>ПРИВОД ПОВОРОТНО-ОТКИДНОЙ</b>  <b>KYO-ZG</b> <b>15.5 mm</b>	450-700 570-800 700-1200 800-1300 900-1400 1200-1700 1700-2200 1950-2450
2	İSP Z165 İSP Z300 İSP Z400 İSP Z600 İSP Z800 İSP Z1000 İSP Z1200 İSP Z1400 İSP Z1600 İSP Z1800 İSP Z2000 İSP Z2200	<b>TEK AÇILIM İSPANYOLET ZAMAK GÖBEK</b> <b>SIDE HUNG ESPAGNOLETTE ZINC HOUSING</b> <b>ПРИВОД ПОВОРОТНЫЙ (ЦИНК)</b>  <b>KYO-ZG</b> <b>15.5 mm</b>	165-250 250-400 400-600 600-800 800-1000 1000-1200 1200-1400 1400-1600 1600-1800 1800-2000 2000-2200 2200-2400
3	İSP M300 İSP M400 İSP M600 İSP M800 İSP M1000 İSP M1200 İSP M1400 İSP M1600 İSP M1800 İSP M2000 İSP M2200	<b>TEK AÇILIM İSPANYOLET METAL GÖBEK</b> <b>SIDE HUNG ESPAGNOLETTE METAL HOUSING</b> <b>ПРИВОД ПОВОРОТНЫЙ (METAL)</b>  <b>KYO-ZG</b> <b>15.5 mm</b>	250-400 400-600 600-800 800-1000 1000-1200 1200-1400 1400-1600 1600-1800 1800-2000 2000-2200 2200-2400
4	TAK 101	<b>TEK AÇILIM ALT / ÜST KİLİTLEME</b> <b>SIDE HUNG BOTTOM/TOP LOCK</b> <b>КОНЦЕВОЙ ЗАПОР ПОВОРОТНЫЙ</b>	450-2450
5	HSP Z01	<b>HAREKET SINIRLANDIRMA PARÇASI</b> <b>MOVEMENT LIMITATION PART</b> <b>ОГРАНИЧИТЕЛЬ ЦАПФЫ</b>	-
6	ARK 505-0.1 ARK 505-0.2 ARK 505-1 ARK 505-1.5 ARK 505-2 ARK 505-2.5 ARK 505-3 ARK 505-4	<b>ARKA KİLİTLEME</b> <b>MIDDLE LOCK</b> <b>СРЕДНИЙ ЗАПОР</b>	-800 -800 800-1200 900-1400 1200-1700 1300-1800 1700-2200 2000-2400
7	AKM 107	<b>AYARLI KANAT MENTEŞE</b> <b>DOUBLE SASH ADJUSTABLE TOP HINGE</b> <b>РЕГУЛИРУЕМАЯ ПОВОРОТНАЯ ПЕТЛЯ</b>	-
8	KNM 737-9 KNM 737-13	<b>KANAT MENTEŞE</b> <b>T&amp;T STAY HINGES</b> <b>КРОНШТЕЙН ВЕРХНИЙ</b>  <b>9 / 20 mm</b> <b>13 / 20 mm</b>	-
9	KSM 720	<b>KASA MENTEŞE</b> <b>T&amp;T STAY ARM BEARING</b> <b>ПЕТЛЯ РАМЫ ВЕРХНЯЯ</b>	-
10	HM 90-3	<b>HAREKETLİ MAFSAL - 90 mm</b> <b>DRILL IN CORNER HINGE - 90 mm</b> <b>ПЕТЛЯ СТВОРКИ НИЖНЯЯ - 90 mm</b>  <b>100 KG</b>	-
11	SM 606	<b>SABİT MAFSAL</b> <b>CORNER BEARING</b> <b>ПЕТЛЯ РАМЫ НИЖНЯЯ</b>  <b>100 KG</b>	-
12	KPT 900	<b>5'Li KAPAK TAKIMI</b> <b>COVERS</b> <b>КОМПЛЕКТ ПЕТЛЕВОГО ДЕКОРА</b>	-
13	KK 350-9 KK 350-13	<b>PİM KARŞILIĞI</b> <b>PIN STRIKER</b> <b>ОТВЕТНАЯ ПЛАНКА</b>  <b>9 / 20 mm</b> <b>13 / 20 mm</b>	-

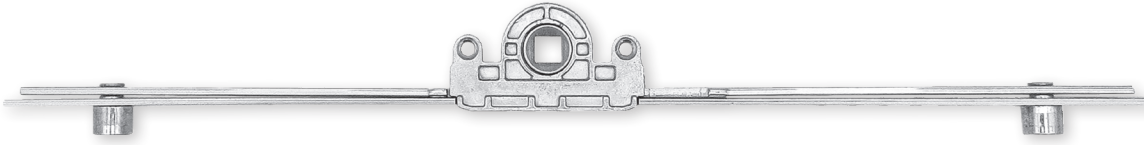



A NO	B NO	TEK AÇILIM İSPANYOLET ZAMAK GÖBEK SIDE HUNG ESPAGNOLETTE ZINC HOUSING ПРИВОД ПОВОРОТНЫЙ (ЦИНК)			
İSP Z165	İSP Z165-G		15.5	165-250	20
İSP Z300	İSP Z300-G		15.5	250-400	20
İSP Z400	İSP Z400-G		15.5	400-600	20
İSP Z600	İSP Z600-G		15.5	600-800	20
İSP Z800	İSP Z800-G		15.5	800-1000	20
İSP Z1000	İSP Z1000-G		15.5	1000-1200	20
İSP Z1200	İSP Z1200-G		15.5	1200-1400	20
İSP Z1400	İSP Z1400-G		15.5	1400-1600	20
İSP Z1600	İSP Z1600-G		15.5	1600-1800	20
İSP Z1800	İSP Z1800-G		15.5	1800-2000	20
İSP Z2000	İSP Z2000-G		15.5	2000-2200	20
İSP Z2200	İSP Z2200-G		15.5	2200-2400	20



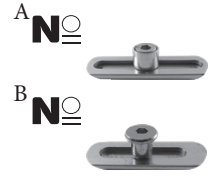
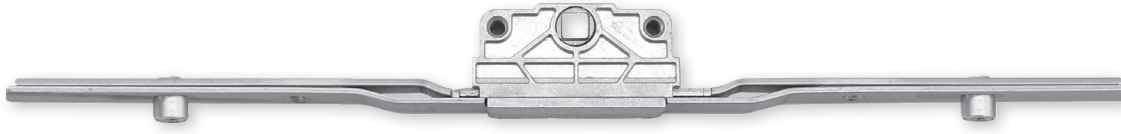

A NO	B NO	TEK AÇILIM İSPANYOLET ZAMAK GÖBEK SIDE HUNG ESPAGNOLETTE ZINC HOUSING ПРИВОД ПОВОРОТНЫЙ (ЦИНК)			
İSP Z400/7.5	İSP Z400-G/7.5		7.5	395-595	20
İSP Z600/7.5	İSP Z600-G/7.5		7.5	595-795	20
İSP Z800/7.5	İSP Z800-G/7.5		7.5	795-995	20
İSP Z1000/7.5	İSP Z1000-G/7.5		7.5	995-1195	20
İSP Z1200/7.5	İSP Z1200-G/7.5		7.5	1195-1395	20
İSP Z1400/7.5	İSP Z1400-G/7.5		7.5	1395-1595	20
İSP Z1600/7.5	İSP Z1600-G/7.5		7.5	1595-1795	20
İSP Z1800/7.5	İSP Z1800-G/7.5		7.5	1795-1995	20
İSP Z2000/7.5	İSP Z2000-G/7.5		7.5	1995-2195	20
İSP Z2200/7.5	İSP Z2200-G/7.5		7.5	2195-2395	20

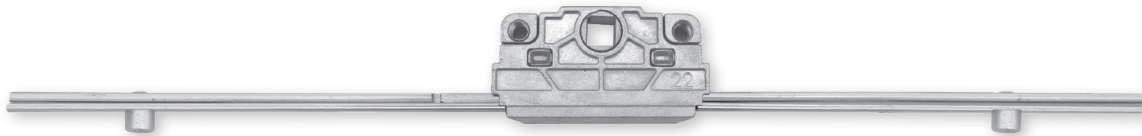

A NO	B NO	TEK AÇILIM İSPANYOLET ZAMAK GÖBEK SIDE HUNG ESPAGNOLETTE ZINC HOUSING ПРИВОД ПОВОРОТНЫЙ (ЦИНК)			
İSP Z300/19.5	İSP Z300-G/19.5		19.5	250-400	20
İSP Z400/19.5	İSP Z400-G/19.5		19.5	400-600	20
İSP Z600/19.5	İSP Z600-G/19.5		19.5	600-800	20
İSP Z800/19.5	İSP Z800-G/19.5		19.5	800-1000	20
İSP Z1000/19.5	İSP Z1000-G/19.5		19.5	1000-1200	20
İSP Z1200/19.5	İSP Z1200-G/19.5		19.5	1200-1400	20
İSP Z1400/19.5	İSP Z1400-G/19.5		19.5	1400-1600	20
İSP Z1600/19.5	İSP Z1600-G/19.5		19.5	1600-1800	20
İSP Z1800/19.5	İSP Z1800-G/19.5		19.5	1800-2000	20
İSP Z2000/19.5	İSP Z2000-G/19.5		19.5	2000-2200	20
İSP Z2200/19.5	İSP Z2200-G/19.5		19.5	2200-2400	20



A NO	B NO	TEK AÇILIM İSPANYOLET ZAMAK GÖBEK SIDE HUNG ESPAGNOLETTE ZINC HOUSING ПРИВОД ПОВОРОТНЫЙ (ЦИНК)			
İSP Z300/22	İSP Z300-G/22		22	250-400	20
İSP Z400/22	İSP Z400-G/22		22	400-600	20
İSP Z600/22	İSP Z600-G/22		22	600-800	20
İSP Z800/22	İSP Z800-G/22		22	800-1000	20
İSP Z1000/22	İSP Z1000-G/22		22	1000-1200	20
İSP Z1200/22	İSP Z1200-G/22		22	1200-1400	20
İSP Z1400/22	İSP Z1400-G/22		22	1400-1600	20
İSP Z1600/22	İSP Z1600-G/22		22	1600-1800	20
İSP Z1800/22	İSP Z1800-G/22		22	1800-2000	20
İSP Z2000/22	İSP Z2000-G/22		22	2000-2200	20
İSP Z2200/22	İSP Z2200-G/22		22	2200-2400	20

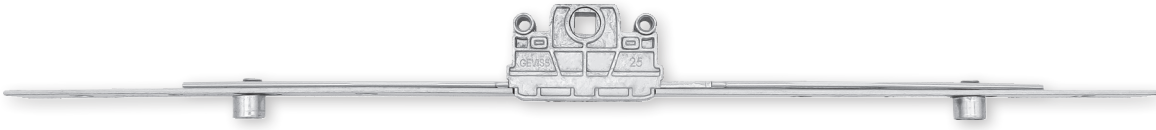

A NO	B NO	TEK AÇILIM İSPANYOLET ZAMAK GÖBEK SIDE HUNG ESPAGNOLETTE ZINC HOUSING ПРИВОД ПОВОРОТНЫЙ (ЦИНК)			
İSP Z300/25	İSP Z300-G/25		25	250-400	15
İSP Z400/25	İSP Z400-G/25		25	400-600	15
İSP Z600/25	İSP Z600-G/25		25	600-800	15
İSP Z800/25	İSP Z800-G/25		25	800-1000	15
İSP Z1000/25	İSP Z1000-G/25		25	1000-1200	15
İSP Z1200/25	İSP Z1200-G/25		25	1200-1400	15
İSP Z1400/25	İSP Z1400-G/25		25	1400-1600	15
İSP Z1600/25	İSP Z1600-G/25		25	1600-1800	15
İSP Z1800/25	İSP Z1800-G/25		25	1800-2000	15
İSP Z2000/25	İSP Z2000-G/25		25	2000-2200	15
İSP Z2200/25	İSP Z2200-G/25		25	2200-2400	15

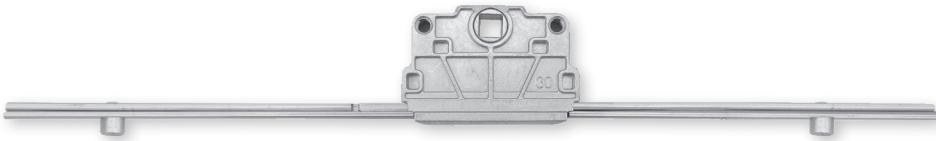

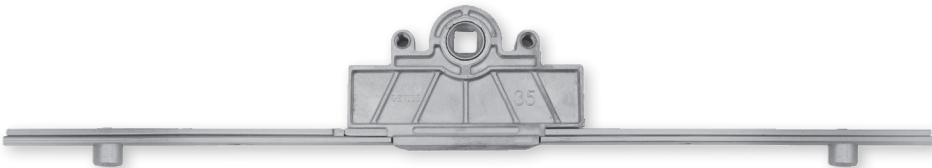

A NO	B NO	TEK AÇILIM İSPANYOLET ZAMAK GÖBEK SIDE HUNG ESPAGNOLETTE ZINC HOUSING ПРИВОД ПОВОРОТНЫЙ (ЦИНК)			
İSP Z300/30	İSP Z300-G/30		30	250-400	10
İSP Z400/30	İSP Z400-G/30		30	400-600	10
İSP Z600/30	İSP Z600-G/30		30	600-800	10
İSP Z800/30	İSP Z800-G/30		30	800-1000	10
İSP Z1000/30	İSP Z1000-G/30		30	1000-1200	10
İSP Z1200/30	İSP Z1200-G/30		30	1200-1400	10
İSP Z1400/30	İSP Z1400-G/30		30	1400-1600	10
İSP Z1600/30	İSP Z1600-G/30		30	1600-1800	10
İSP Z1800/30	İSP Z1800-G/30		30	1800-2000	10
İSP Z2000/30	İSP Z2000-G/30		30	2000-2200	10
İSP Z2200/30	İSP Z2200-G/30		30	2200-2400	10



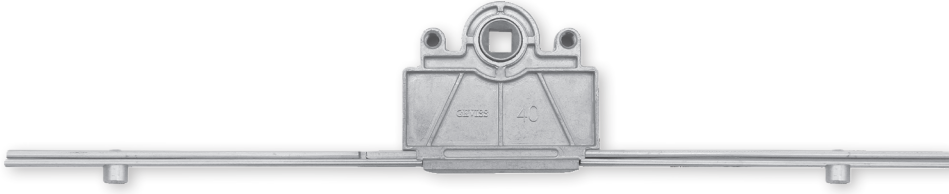

A NO	B NO	TEK AÇILIM İSPANYOLET ZAMAK GÖBEK SIDE HUNG ESPAGNOLETTE ZINC HOUSING ПРИВОД ПОВОРОТНЫЙ (ЦИНК)			
İSP Z1600/35	İSP Z1600-G/35		35	1600-1800	10
İSP Z1800/35	İSP Z1800-G/35		35	1800-2000	10
İSP Z2000/35	İSP Z2000-G/35		35	2000-2200	10
İSP Z2200/35	İSP Z2200-G/35		35	2200-2400	10



A NO	B NO	TEK AÇILIM İSPANYOLET ZAMAK GÖBEK SIDE HUNG ESPAGNOLETTE ZINC HOUSING ПРИВОД ПОВОРОТНЫЙ (ЦИНК)			
İSP Z1600/40	İSP Z1600-G/40		40	1600-1800	10
İSP Z1800/40	İSP Z1800-G/40		40	1800-2000	10
İSP Z2000/40	İSP Z2000-G/40		40	2000-2200	10
İSP Z2200/40	İSP Z2200-G/40		40	2200-2400	10



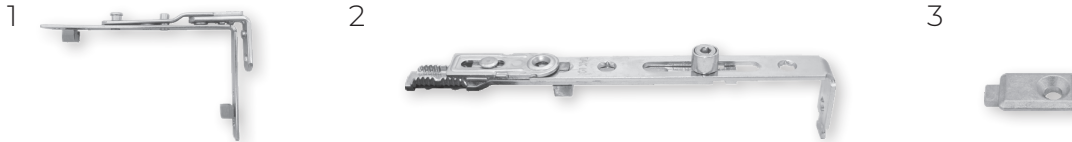

A NO	B NO	TEK AÇILIM İSPANYOLET METAL GÖBEK SIDE HUNG ESPAGNOLETTE METAL HOUSING ПРИВОД ПОВОРОТНЫЙ (МЕТАЛ)			
İSP M300	İSP M300-G		15.5	250-400	20
İSP M400	İSP M400-G		15.5	400-600	20
İSP M600	İSP M600-G		15.5	600-800	20
İSP M800	İSP M800-G		15.5	800-1000	20
İSP M1000	İSP M1000-G		15.5	1000-1200	20
İSP M1200	İSP M1200-G		15.5	1200-1400	20
İSP M1400	İSP M1400-G		15.5	1400-1600	20
İSP M1600	İSP M1600-G		15.5	1600-1800	20
İSP M1800	İSP M1800-G		15.5	1800-2000	20
İSP M2000	İSP M2000-G		15.5	2000-2200	20
İSP M2200	İSP M2200-G		15.5	2200-2400	20



NO	TEK AÇILIM BAĞLANTI AKSESUARLARI SIDE HUNG CONNECTION ACCESSORIES КОМПЛЕКТУЮЩИЕ АКССУАРЫ ПОВОРОТНЫХ ОКОН		
1 AKM 107	AYARLI KANAT MENTEŞE / DOUBLE SASH ADJUSTABLE TOP HINGE / РЕГУЛИРУЕМАЯ ПОВОРОТНАЯ ПЕТЛЯ	-	100
2 TAK 101	TEK AÇILIM ALT - ÜST KİLİTLEME / SIDE HUNG BOTTOM - TOP LOCK / КОНЦЕВОЙ ЗАПОР ПОВОРОТНЫЙ	450-2450	50
3 HSP Z01	HAREKET SINIRLANDIRMA PARÇASI / MOVEMENT LIMITATION PART / ОГРАНИЧИТЕЛЬ ЦАПФЫ	-	100



NO	CONTA BASKI MENTEŞELERİ GASKET PRESSURE HINGE ПЕТЛИ ПРИЖИМА		
1 GOB 218		-	100
2 GOB 218-9		9	100
3 GOB 218-13		13	100
4 OBM 217		-	200

**1**

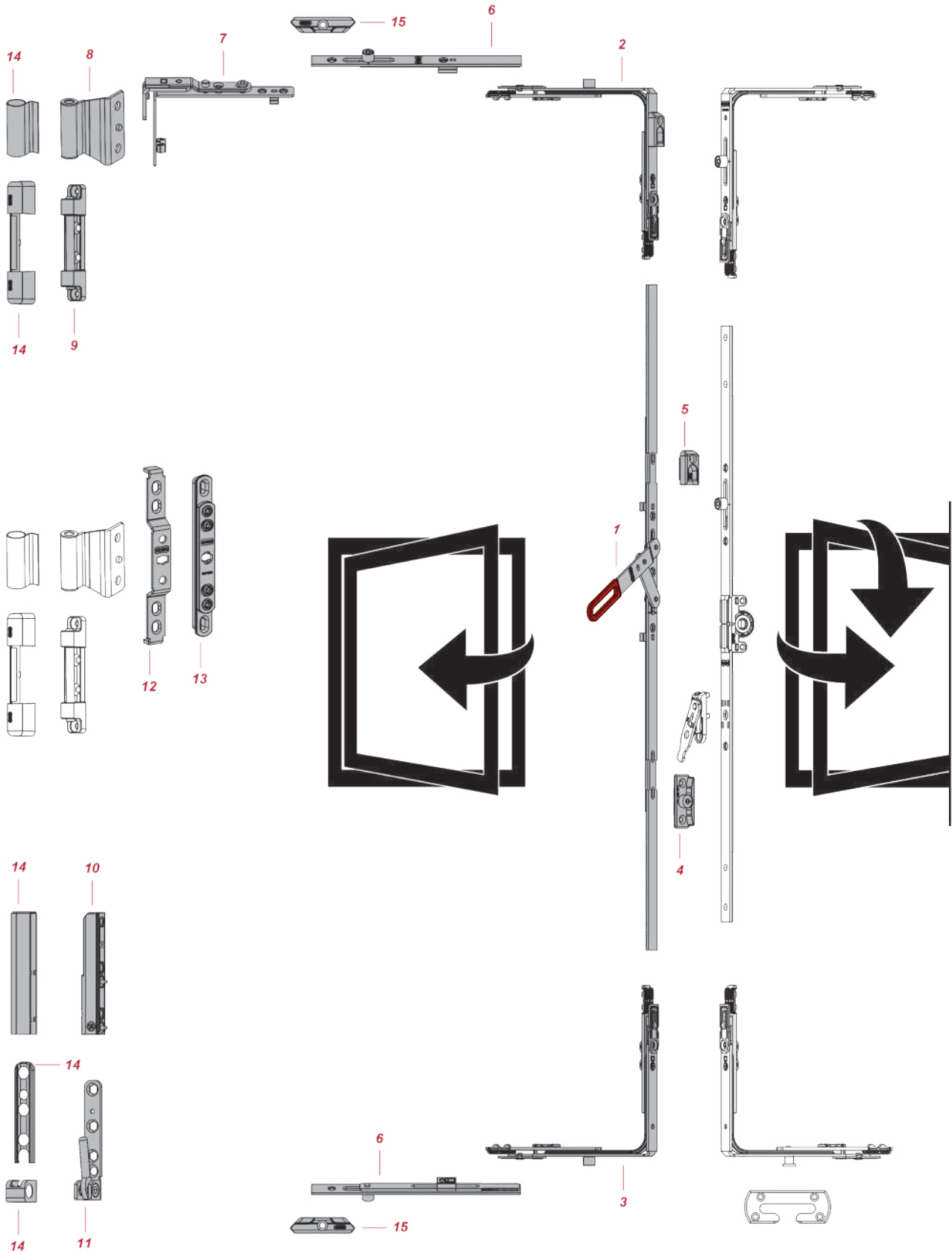



	NO	ÜRÜN ADI PRODUCT NAME НАИМЕНОВАНИЕ	
1	LKI 250-01 LKI 250-02 LKI 250-03 LKI 250-04 LKI 250-05 LKI 250-06	<b>LEVYE KOLLU İSPANYOLET</b> DOUBLE SASH GEAR HANDLE ШТУЛЬПОВЫЙ ПРИВОД	500 - 700 700 - 1200 900 - 1400 1200 - 1700 1700 - 2200 1950 - 2450
2	KDH CK1	<b>KÖŞE DÖNÜŞ ÇİFT KANAT UYUMLU</b> CORNER TRANSMISSION ADAPTABLE DOUBLE SASH SYSTEM УГЛОВОЙ ПЕРЕКЛЮЧАТЕЛЬ	500-2450
3	KDH 303	<b>KÖŞE DÖNÜŞ HAREKETİ</b> CORNER TRANSMISSION УГЛОВОЙ ПЕРЕКЛЮЧАТЕЛЬ	500-2450
4	LMK 410	<b>MİKROLİFT KARŞILIĞI - LEVYE KOL İSPANYOLET UYUMLU</b> MICROLIFTING STRIKER - FOR DOUBLE SASH GEAR HANDLE ОТВЕТНАЯ ПЛАНКА ПОД МИКРОЛИФТ - ШТУЛЬПОВЫЙ ПРИВОД	-
5	HOK 340	<b>LEVYE KOL PİM KARŞILIĞI</b> DOUBLE SASH GEAR HANDLE PIN STRIKER ОТВЕТНАЯ ПЛАНКА ДЛЯ ШТУЛЬПОВОГО ЗАПORA	-
6	IDK 213-1 IDK 213-2	<b>İLAVE DÜZ KİLİTLEME</b> ADDITIONAL STRAIGHT LOCKING СРЕДНИЙ ЗАПОР ДОПОЛНИТЕЛЬНЫЙ	800 - 1200 1200 - 1700
7	AKM 107	<b>AYARLI KANAT MENTEŞE</b> DOUBLE SASH ADJUSTABLE TOP HINGE РЕГУЛИРУЕМАЯ ПОВОРОТНАЯ ПЕТЛЯ	-
8	KNM 737-9 KNM 737-13	<b>KANAT MENTEŞE</b> T&T STAY HINGES КРОНШТЕЙН ВЕРХНИЙ	9 / 20 mm 13 / 20 mm -
9	KSM 720	<b>KASA MENTEŞE</b> T&T STAY ARM BEARING ПЕТЛЯ РАМЫ ВЕРХНЯЯ	-
10	HM 90-3	<b>HAREKETLİ MAFSAL - 90 mm</b> DRILL IN CORNER HINGE - 90 mm ПЕТЛЯ СТВОРКИ НИЖНЯЯ - 90 mm	100 KG -
11	SM 606	<b>SABİT MAFSAL</b> CORNER BEARING ПЕТЛЯ РАМЫ НИЖНЯЯ	100 KG -
12	ORM 208	<b>ORTA MENTEŞE</b> MIDDLE HINGE ПОВОРОТНАЯ СРЕДНЯЯ ПЕТЛЯ	-
13	OMA 308	<b>AYARLI ORTA MENTEŞE</b> ADJUSTABLE MIDDLE HINGE СРЕДНЯЯ ПЕТЛЯ РЕГУЛИРУЕМАЯ	-
14	KPT 900	<b>5'Li KAPAK TAKIMI</b> COVERS КОМПЛЕКТ ПЕТЛЕВОГО ДЕКОРА	-
15	KK 350-9 KK 350-13	<b>PİM KARŞILIĞI</b> PIN STRIKER ОТВЕТНАЯ ПЛАНКА	9 / 20 mm 13 / 20 mm -

2

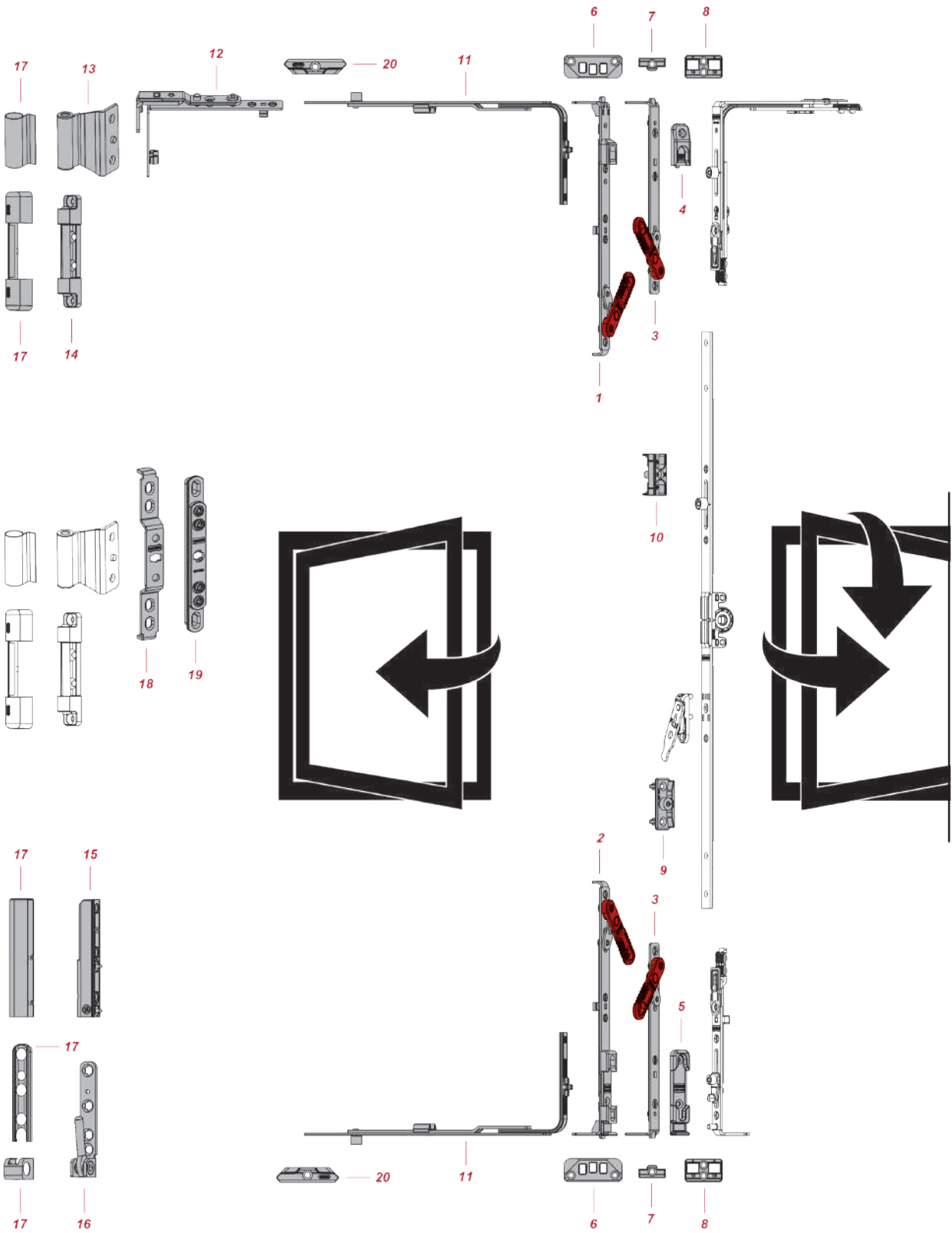

	NO	ÜRÜN ADI PRODUCT NAME НАИМЕНОВАНИЕ	
1	SRG 934/U	<b>ÇİFT KANAT ÇİFT AÇILIM UYUMLU SÜRGÜ ( ÜST )</b> DOUBLE SASH BOTTOM SHOOT ( TOP ) ВЕРХНИЙ ШПИНГАЛЕТ ПОД ПОВОРОТНО-ОТКИДНУЮ СИСТЕМУ	-
2	SRG 934/A	<b>ÇİFT KANAT ÇİFT AÇILIM UYUMLU SÜRGÜ ( ALT )</b> DOUBLE SASH BOTTOM SHOOT ( BOTTOM ) НИЖНИЙ ШПИНГАЛЕТ ПОД ПОВОРОТНО-ОТКИДНУЮ СИСТЕМУ	-
3	SRG-PU2	<b>ÇİFT KANAT SÜRGÜ UZUN</b> DOUBLE SASH LONG BOLT ШПИНГАЛЕТ - ДЛИННЫЙ	-
4	CSK-U01	<b>SÜRGÜ UYUMLU PİM KARŞILIĞI</b> PIN STRIKER FOR DOUBLE SASH BOLT ОТВЕТНАЯ ПЛАНКА ЦАПФЫ НА ШПИНГАЛЕТ	-
5	CSK-A02	<b>SÜRGÜ UYUMLU ÇİFT AÇILIM DEVRİLME KARŞILIĞI</b> T & T LOCKING PLATE FOR DOUBLE SASH BOLT ПОВОРОТНО-ОТКИДНАЯ ПЛАНКА НА ШПИНГАЛЕТ	-
6	SPK 260-9 SPK 270-13	<b>SÜRGÜ KARŞILIĞI</b> DOUBLE SASH SHOOT LOCKING PLATE ОТВЕТНАЯ ПЛАНКА ПОД ШПИНГАЛЕТ	9 / 20 mm 13 / 20 mm
7	CSK-Z07	<b>SÜRGÜ KARŞILIK ECO</b> DOUBLE SASH BOLT STRIKER - ECO ОТВЕТНАЯ ПЛАНКА ДЛЯ ШПИНГАЛЕТА МИНИ	-
8	CSK-Z05	<b>SÜRGÜ KARŞILIĞI</b> DOUBLE SASH SHOOT LOCKING PLATE ОТВЕТНАЯ ПЛАНКА ПОД ШПИНГАЛЕТ	-
9	LMK 420	<b>HAREKETLİ ORTA KAYIT MİKROFİLT KARŞILIĞI</b> DOUBLE SASH MICROLIFTING STRIKER ШТУЛЬПОВАЯ ОТВЕТНАЯ ПЛАНКА ПОД МИКРОЛИФТ	-
10	CKK 01	<b>ÇİFT KANAT İSPANYOLET PİM KARŞILIĞI</b> DOUBLE SASH ESPAGNOLETTE STRIKER ШТУЛЬПОВАЯ ОТВЕТКА - ЦИНК	-
11	ARK 505-0.1 ARK 505-0.2 ARK 505-1 ARK 505-1.5 ARK 505-2 ARK 505-2.5 ARK 505-3 ARK 505-4	<b>ARKA KİLİTLEME</b> MIDDLE LOCK СРЕДНИЙ ЗАПОР	- 800 - 800 800 - 1200 900 - 1400 1200 - 1700 1300 - 1800 1700 - 2200 2000 - 2400
12	AKM 107	<b>AYARLI KANAT MENTEŞE</b> DOUBLE SASH ADJUSTABLE TOP HINGE РЕГУЛИРУЕМАЯ ПОВОРОТНАЯ ПЕТЛЯ	-
13	KNM 737-9 KNM 737-13	<b>KANAT MENTEŞE</b> T&T STAY HINGES КРОНШТЕЙН ВЕРХНИЙ	9 / 20 mm 13 / 20 mm
14	KSM 720	<b>KASA MENTEŞE</b> T&T STAY ARM BEARING ПЕТЛЯ РАМЫ ВЕРХНЯЯ	-
15	HM 90-3	<b>HAREKETLİ MAFSAL - 90 mm</b> DRILL IN CORNER HINGE - 90 mm ПЕТЛЯ СТВОРКИ НИЖНЯЯ - 90 mm	100 KG
16	SM 606	<b>SABİT MAFSAL</b> CORNER BEARING ПЕТЛЯ РАМЫ НИЖНЯЯ	100 KG
17	KPT 900	<b>5'li KAPAK TAKIMI</b> COVERS КОМПЛЕКТ ПЕТЛЕВОГО ДЕКОРА	-
18	ORM 208	<b>ORTA MENTEŞE</b> MIDDLE HINGE ПОВОРОТНАЯ СРЕДНЯЯ ПЕТЛЯ	-
19	OMA 308	<b>AYARLI ORTA MENTEŞE</b> ADJUSTABLE MIDDLE HINGE СРЕДНЯЯ ПЕТЛЯ РЕГУЛИРУЕМАЯ	-
20	KK 350-9 KK 360-13	<b>PİM KARŞILIĞI</b> PIN STRIKER ОТВЕТНАЯ ПЛАНКА	9 / 20 mm 13 / 20 mm

**3**

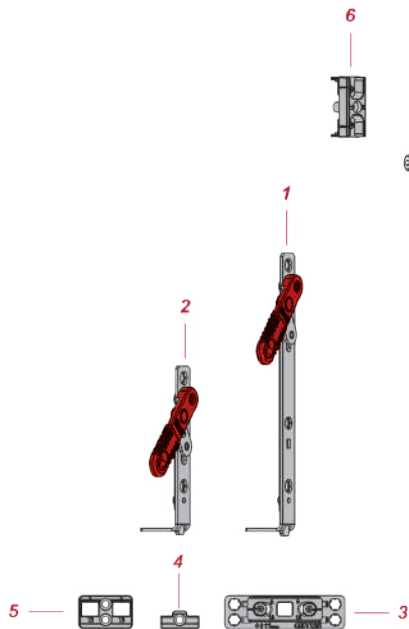
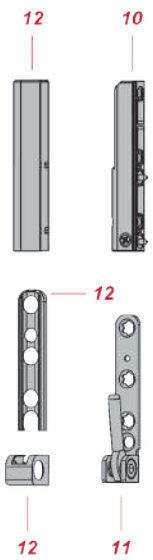
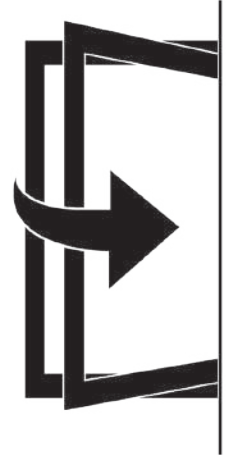
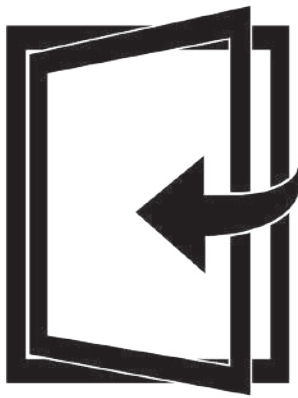
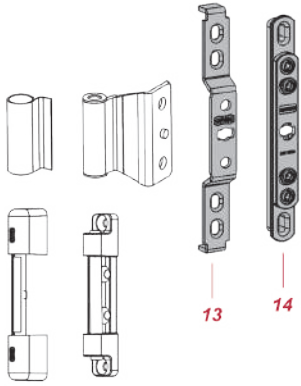
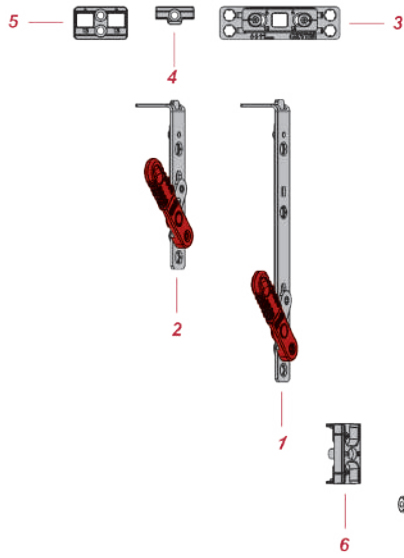
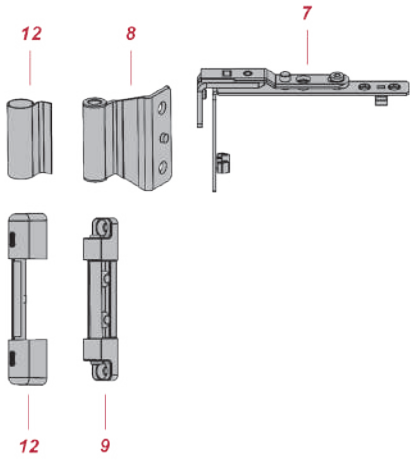

	NO	ÜRÜN ADI PRODUCT NAME НАИМЕНОВАНИЕ	
1	SRG-PU2	<b>ÇİFT KANAT SÜRGÜ UZUN</b> DOUBLE SASH BOLT LONG ШПИНГАЛЕТ ШТУЛЬПА ДЛИННЫЙ	-
2	SRG-PK1	<b>ÇİFT KANAT SÜRGÜ KISA</b> DOUBLE SASH BOLT SHORT ШПИНГАЛЕТ ШТУЛЬПА КОРОТКИЙ	-
3	CSK-S03	<b>AYARLI SAC SÜRGÜ KARŞILIĞI</b> ADJUSTABLE LOCKING BOLT STRIKER ОТВЕТНАЯ ПЛАНКА ШПИНГАЛЕТА РЕГУЛИРУЕМАЯ	-
4	CSK-Z07	<b>SÜRGÜ KARŞILIK ECO</b> DOUBLE SASH BOLT STRIKER - ECO ОТВЕТНАЯ ПЛАНКА ДЛЯ ШПИНГАЛЕТА МИНИ	-
5	CSK-Z05	<b>SÜRGÜ KARŞILIĞI</b> DOUBLE SASH SHOOT LOCKING PLATE ОТВЕТНАЯ ПЛАНКА ПОД ШПИНГАЛЕТ	-
6	CKK 01	<b>ÇİFT KANAT İSPANYOLET PİM KARŞILIĞI</b> DOUBLE SASH ESPAGNOLETTE STRIKER ШТУЛЬПОВАЯ ОТВЕТКА - ЦИНК	-
7	AKM 107	<b>AYARLI KANAT MENTEŞE</b> DOUBLE SASH ADJUSTABLE TOP HINGE РЕГУЛИРУЕМАЯ ПОВОРОТНАЯ ПЕТЛЯ	-
8	KNM 737-9 KNM 737-13	<b>KANAT MENTEŞE</b> T&T STAY HINGES КРОНШТЕЙН ВЕРХНИЙ	9 / 20 mm 13 / 20 mm
9	KSM 720	<b>KASA MENTEŞE</b> T&T STAY ARM BEARING ПЕТЛЯ РАМЫ ВЕРХНЯЯ	-
10	HM 90-3	<b>HAREKETLİ MAFSAL - 90 mm</b> DRILL IN CORNER HINGE - 90 mm ПЕТЛЯ СТВОРКИ НИЖНЯЯ - 90 mm	100 KG
11	SM 606	<b>SABİT MAFSAL</b> CORNER BEARING ПЕТЛЯ РАМЫ НИЖНЯЯ	100 KG
12	KPT 900	<b>5'Li KAPAK TAKIMI</b> COVERS КОМПЛЕКТ ПЕТЛЕВОГО ДЕКОРА	-
13	ORM 208	<b>ORTA MENTEŞE</b> MIDDLE HINGE ПОВОРОТНАЯ СРЕДНЯЯ ПЕТЛЯ	-
14	OMA 308	<b>AYARLI ORTA MENTEŞE</b> ADJUSTABLE MIDDLE HINGE СРЕДНЯЯ ПЕТЛЯ РЕГУЛИРУЕМАЯ	-

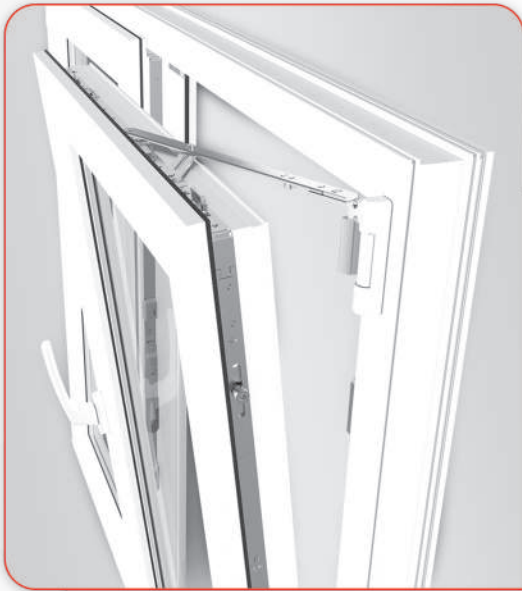
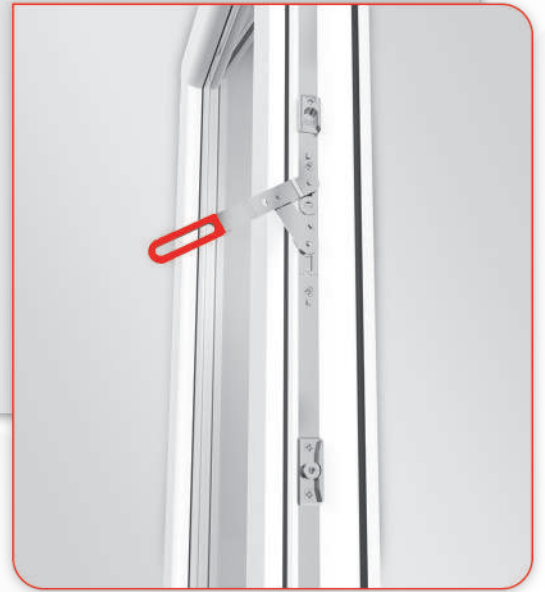



№	LEVYE KOLLU İSPANYOLET DOUBLE SASH GEAR HANDLE ШТУЛЬПОВЫЙ ПРИВОД		
LKI 250-01		500-700	10
LKI 250-02		700-1200	10
LKI 250-03		900-1400	10
LKI 250-04		1200-1700	10
LKI 250-05		1700-2200	10
LKI 250-06		1950-2450	10

1



2



№	ÇİFT AÇILIM UYUMLU SÜRGÜLER TILT & TURN SUITABLE BOLTS ШПИНГАЛЕТЫ ШТУЛЬПА ДЛЯ ДВУСТВОРЧАТЫХ СИСТЕМ		
1 SRG 934/A		500-2450	100
2 SRG 934/U		500-2450	100

1



2



3



№	ÇİFT KANAT UYUMLU SÜRGÜLER DOUBLE SASH SUITABLE BOLTS ШПИНГАЛЕТЫ ШТУЛЬПА		
1 SRG-PK1		400-2450	100
2 SRG-PU2		400-2450	100
3 SRG-KP3		400-2450	100

1



2



PLASTIC

3

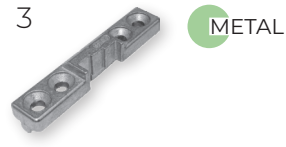

METAL

№	PLASTİK ÇİFT KANAT SÜRGÜ DOUBLE SASH BOLT - PLASTIC ШТУЛЬПОВЫЙ ШПИНГАЛЕТ - ПЛАСТИК		
1 SRG-PS4		400-2450	200
2 SK-P01		-	200
3 SK-S01		-	200

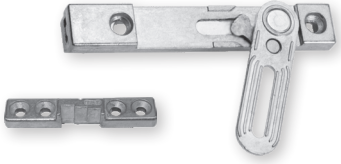

<b>NO</b>	<b>ÇİFT KANAT SÜRGÜ - ZAMAK</b> DOUBLE SASH BOLT - ZINC ШТУЛЬПОВЫЙ ШПИНГАЛЕТ - ЦИНК		
G.SRG.BNZ		400-2450	100

1



2

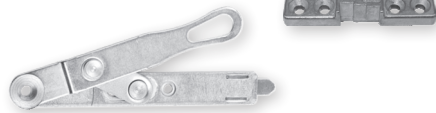

<b>NO</b>	<b>ÇİFT KANAT SÜRGÜ</b> DOUBLE SASH BOLT ШТУЛЬПОВЫЙ ШПИНГАЛЕТ - МЕТАЛЛ		
1	G.SRG.BNU	500-2450	100
2	G.SRG.BNS	450-2450	100

1



2



<b>NO</b>	<b>ÇİFT KANAT FİŞEK SÜRGÜ</b> DOUBLE SASH SHOOT BOLT ШПИНГАЛЕТЫ ШТУЛЬПА		
1	G.SRG.F	500-2450	150
2	G.SRG.K	450-2450	150

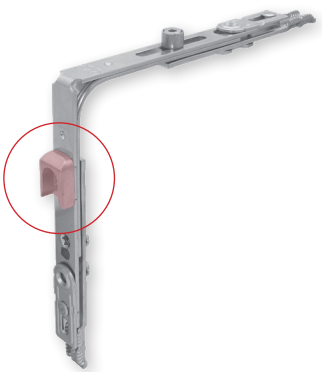

<b>A NO</b>	<b>B NO</b>	<b>KÖŞE DÖNÜŞ ÇİFT KANAT UYUMLU</b> CORNER TRANSMISSION ADAPTABLE DOUBLE SASH SYSTEM УГЛОВОЙ ПЕРЕКЛЮЧАТЕЛЬ			
KDH CK1	KDH CK1-G		350-1350	450-2450	50







 <b>ÇİFT KANAT SÜRGÜ UYUMLU KARŞILIKLAR</b> STRIKER FOR DOUBLE SASH BOLT УНИВЕРСАЛЬНЫЕ ЗАПОРНЫЕ ПЛАНКИ ШТУЛЬПА			
1	CSK - U01		100
2	CSK - A02		100



 <b>AYARLI SAC SÜRGÜ KARŞILIĞI</b> ADJUSTABLE METAL BOLT STRIKER ОТВЕТНАЯ ПЛАНКА ШПИНГАЛЕТА РЕГУЛИРУЕМАЯ			
1	CSK - S03	HOLE DIAMETER : 10 mm x 8,5 mm	9/13
2	CSK - S04	HOLE DIAMETER : 10 mm x 8,5 mm	9/13





 <b>ÇİFT KANAT SÜRGÜ KARŞILIKLARI</b> DOUBLE SASH BOLT STRIKER ОТВЕТНЫЕ ПЛАНКИ ШПИНГАЛЕТА - ЦИНК			
1	SPK 260-9		9
2	SPK 270-13		13
3	CSK - Z05		9 / 13
4	CSK - P06		9 / 13
5	CSK - Z07		9 / 13



 <b>ÇİFT KANAT HAREKETLİ ORTA KAYIT UYUMLU KARŞILIKLAR</b> STRIKERS FOR DOUBLE SASH ESPAGNOLETTE WITH HANDLE ОТВЕТНЫЕ ПЛАНКИ ДЛЯ ДВУСТВОРЧАТОЙ СИСТЕМЫ			
1	CKK 01		500
2	LMK 420		100
3	SAK 240		100



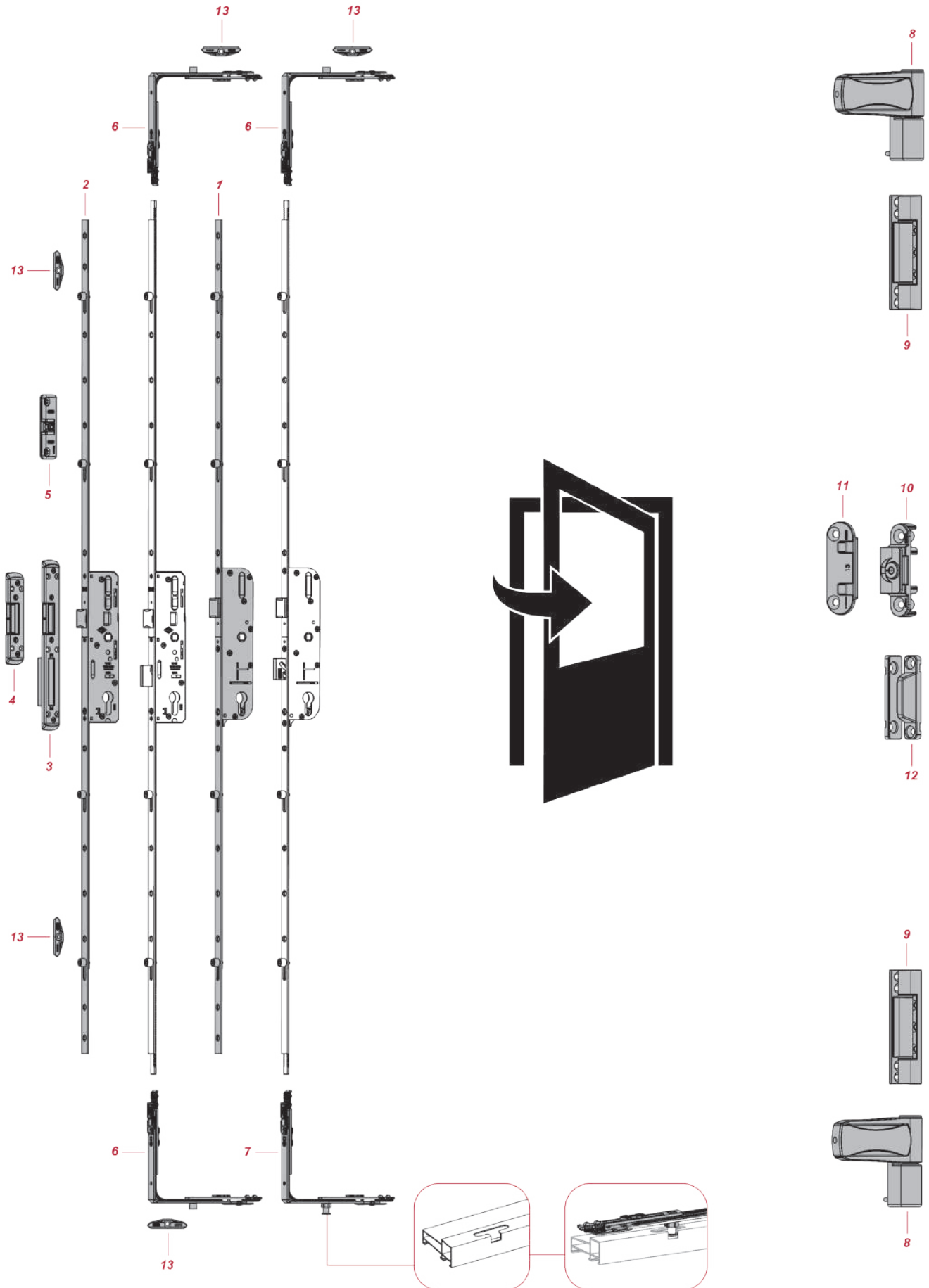

 <b>LEVYE KOL UYUMLU KARŞILIKLAR</b> PIN STRIKERS FOR DOUBLE SASH GEAR ОТВЕТКИ ДЛЯ ШТУЛЬПОВОГО ПРИВОДА			
1	LMK 410		100
2	HOK 340		100
3	HOK 340-G		100

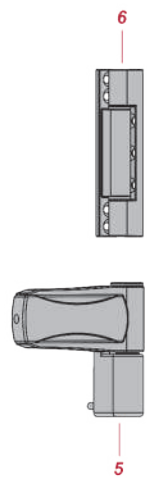
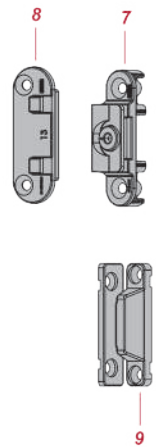
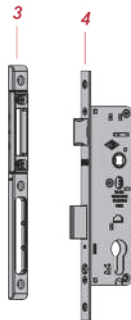
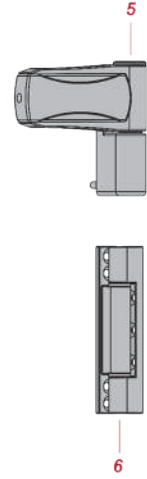

NO	ÜRÜN ADI PRODUCT NAME НАИМЕНОВАНИЕ				
1	KKI 250-1	<b>KİLİTLİ KAPI İSPANYOLETİ</b> LOCKABLE DOOR ESPAGNOLETTE ДВЕРНОЙ МНОГО ЗАПОРНЫЙ ЗАМОК  <b>PLASTİK GÖVDELİ / SINGLE SIDE PLASTIC / ПЛАСТИКОВЫЙ КОРПУС</b>	85	25	1600-1800
	KKI 250-2		85	25	1800-2000
	KKI 250-3		85	25	2000-2200
	KKI 28/85-1		85	28	1600-1800
	KKI 28/85-2		85	28	1800-2000
	KKI 28/85-3		85	28	2000-2200
	KKI 350-1		85	35	1600-1800
	KKI 350-2		85	35	1800-2000
KKI 350-3	85	35	2000-2200		
2	KKI M.2592-1600	<b>KİLİTLİ KAPI İSPANYOLETİ</b> LOCKABLE DOOR ESPAGNOLETTE ДВЕРНОЙ МНОГО ЗАПОРНЫЙ ЗАМОК  <b>METAL GÖVDELİ / DOUBLE SIDE METAL / МЕТАЛЛИЧЕСКИЙ КОРПУС</b>	92	25	1600-1800
	KKI M.2592-1800		92	25	1800-2000
	KKI M.2592-2000		92	25	2000-2200
	KKI M.3592-1600		92	35	1600-1800
	KKI M.3592-1800		92	35	1800-2000
KKI M.3592-2000	92	35	2000-2200		
3	KIK 02-S	<b>AYARLI KİLİT KARŞILIĞI METAL - UZUN</b> ADJUSTABLE LOCKING PLATE METAL - LONG МЕТАЛЛИЧЕСКАЯ ОТВЕТКА ЗАМКА - ДЛИННЫЙ			-
4	KIK 01-S	<b>AYARLI KİLİT KARŞILIĞI METAL - KISA</b> ADJUSTABLE LOCKING PLATE METAL - SHORT МЕТАЛЛИЧЕСКАЯ ОТВЕТКА ЗАМКА - КОРОТКИЙ			-
5	BLK 211-9	<b>BALKON ÇİTÇİTİ</b> BALCONY CLIPS БАЛКОННАЯ ЗАЩЕЛКА	9 / 20 mm		-
	BLK 211-13		13 / 20 mm		-
6	KDH 303	<b>KÖŞE DÖNÜŞ HAREKETİ</b> CORNER TRANSMISSION УГЛОВОЙ ПЕРЕКЛЮЧАТЕЛЬ			450-2450
7	KDE 313	<b>KÖŞE DÖNÜŞ HAREKETİ EŞİK PROFİLİNDEN DEVRİLMELİ</b> CORNER TRANSMISSION PART TILTS FROM FRAME PROFILE - STANDARD PIN УГЛОВОЙ ПЕРЕКЛЮЧАТЕЛЬ ДЛЯ АЛЮМИНИЕВОВОГО ПОРОГА - СТАНДАРТНАЯ ЦАПФА			450-2450
8	3DM 105	<b>3D MENTEŞE</b> 3D ADJUSTABLE HINGE ПЕТЛЯ 3D	ALUMINIUM ZINC 160 KG / ALUMINIUM		-
	3DM 108				-
	3DM 160				-
9	PME 90	<b>90 MM PLASTİK KAPLAMA SAC MENTEŞE</b> 90 MM STEEL HINGE WITH PLASTIC COVERING 90 MM METALLO PLASTIKOVAYA PETLJA	WITH NAIL		-
	PME T90				-
10	GOB 218	<b>GİZLİ BASKI MENTEŞE</b> HIDDEN PRESSURE HINGE СКРЫТАЯ ПЕТЛЯ СРЕДНЕГО ПРИЖИМА			-
11	GOB 218-9	<b>GİZLİ BASKI MENTEŞE KARŞILIK</b> HIDDEN PRESSURE HINGE STRIKER ОТВЕТНАЯ ПЛАНКА НЕВИДИМОЙ ПЕТЛИ	9 / 20 mm 13 / 20 mm		-
	GOB 218-13				-
12	OVM 217	<b>ORTA BASKI MENTEŞE</b> MIDDLE PRESSURE HINGE ПЕТЛЯ СРЕДНЕГО ПРИЖИМА			-
13	KK 350-9	<b>PİM KARŞILIĞI</b> PIN STRIKER ОТВЕТНАЯ ПЛАНКА			-
	KK 350-13			-	



	NO	ÜRÜN ADI PRODUCT NAME НАИМЕНОВАНИЕ			
1	SRG-KP3	<b>ÇİFT KANAT KAPI SÜRGÜ</b> DOUBLE SASH DOOR BOLT ДВЕРНОЙ ШПИНГАЛЕТ ШТУЛЬПА			-
2	CSK-S04B	<b>AYARLI SAC KAPI SÜRGÜ KARŞILIĞI</b> ADJUSTABLE STRIKER FOR DOOR BOLT ( METAL ) РЕГУЛИРУЕМАЯ ОТВЕТНАЯ ПЛАНКА ДВЕРНОГО ШПИНГАЛЕТА			-
3	CKK 02	<b>ÇİFT KANAT KİLİTLİ İSPANYOLET KARŞILIĞI</b> DOUBLE SASH LOCKABLE ESPAGNOLETTE STRIKER ОТВЕТНАЯ ПЛАНКА ДЛЯ ДВУСТВОРЧАТЫХ ДВЕРЕЙ			-
4	G.16.2085.15 G.16.2585.15 G.16.3085.15 G.16.3585.15 G.16.4085.15	<b>PVC - SİLİNDİRLİ KAPI KİLİDİ</b> PVC - DOOR LOCK WITH CYLINDER HOLE ДВЕРНОЙ ЗАМОК С ЦИЛИНДРОМ ДЛЯ ПВХ	85 85 85 85 85	20 25 30 35 40	-
5	3DM 105 3DM 108 3DM 160	<b>3D MENTEŞE</b> 3D ADJUSTABLE HINGE ПЕТЛЯ 3D	ALUMINIUM ZINC 160 KG / ALUMINIUM		-
6	PME 90 PME T90	<b>90 MM PLASTİK KAPLAMA SAC MENTEŞE</b> 90 MM STEEL HINGE WITH PLASTIC COVERING 90 MM METALLO PLASTIKOVAYA PETLJA	WITH NAIL		-
7	GOB 218	<b>GİZLİ BASKI MENTEŞE</b> HIDDEN PRESSURE HINGE СКРЫТАЯ ПЕТЛЯ СРЕДНЕГО ПРИЖИМА			-
8	GOB 218-9 GOB 218-13	<b>GİZLİ BASKI MENTEŞE KARŞILIK</b> HIDDEN PRESSURE HINGE STRIKER ОТВЕТНАЯ ПЛАНКА НЕВИДИМОЙ ПЕТЛИ	9 / 20 mm 13 / 20 mm		-
9	OBM 217	<b>ORTA BASKI MENTEŞE</b> MIDDLE PRESSURE HINGE ПЕТЛЯ СРЕДНЕГО ПРИЖИМА			-

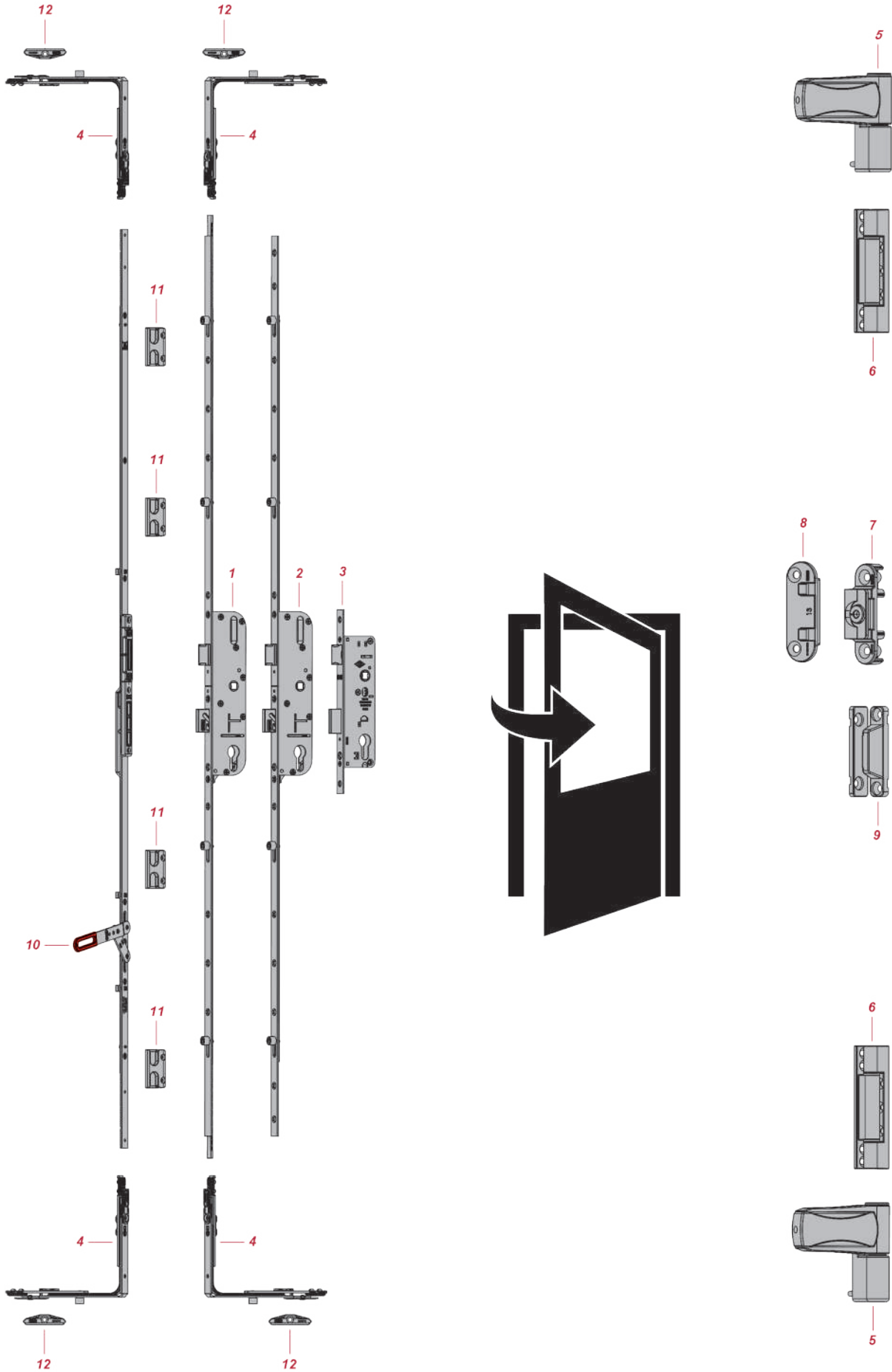

	NO	ÜRÜN ADI PRODUCT NAME НАИМЕНОВАНИЕ			
1	KKI DL 270-1	<b>KİLİTLİ KAPI İSPANYOLETİ (KESİLEBİLİR DİLLİ)</b> LOCKABLE DOOR ESPAGNOLETTE (CUTABLE WITH BOLT) ДВЕРНОЙ МНОГОЗАПОРНЫЙ ЗАМОК (ОТРЕЗНОЙ) (С РИГЕЛЕМ)	85	25	1750-1850
	KKI DL 270-2		85	25	1950-2050
	KKI DL 270-3		85	25	2150-2250
	KKI KSD 28/85-1		85	28	1750-1850
	KKI KSD 28/85-2		85	28	1950-2050
	KKI KSD 28/85-3		85	28	2150-2250
	KKI DL 370-1		85	35	1750-1850
	KKI DL 370-2		85	35	1950-2050
KKI DL 370-3	85	35	2150-2250		
2	KKI DL 250-1	<b>KİLİTLİ KAPI İSPANYOLETİ (DİLLİ)</b> LOCKABLE DOOR ESPAGNOLETTE (WITH BOLT) ДВЕРНОЙ МНОГОЗАПОРНЫЙ ЗАМОК (С РИГЕЛЕМ)	85	25	1600-1800
	KKI DL 250-2		85	25	1800-2000
	KKI DL 250-3		85	25	2000-2200
	KKI DL 28/85-1		85	28	1600-1800
	KKI DL 28/85-2		85	28	1800-2000
	KKI DL 28/85-3		85	28	2000-2200
	KKI DL 350-1		85	35	1600-1800
	KKI DL 350-2		85	35	1800-2000
KKI DL 350-3	85	35	2000-2200		
3	G.16.2085.15	<b>PVC - SİLİNDİRLİ KAPI KİLİDİ</b> PVC - DOOR LOCK WITH CYLINDER HOLE ДВЕРНОЙ ЗАМОК С ЦИЛИНДРОМ ДЛЯ ПВХ	85	20	-
	G.16.2585.15		85	25	
	G.16.3085.15		85	30	
	G.16.3585.15		85	35	
	G.16.4085.15		85	40	
4	KDH 303	<b>KÖŞE DÖNÜŞ HAREKETİ</b> CORNER TRANSMISSION УГЛОВОЙ ПЕРЕКЛЮЧАТЕЛЬ			450-2450
5	3DM 105	<b>3D MENTEŞE</b> 3D ADJUSTABLE HINGE ПЕТЛЯ 3D	ALUMINIUM		-
	3DM 108		ZINC		
	3DM 160		160 KG / ALUMINIUM		
6	PME 90	<b>90 MM PLASTİK KAPLAMA SAC MENTEŞE</b> 90 MM STEEL HINGE WITH PLASTIC COVERING 90 MM METALLO PLASTIKOVAYA PETLYA			-
	PME T90		WITH NAIL		
7	GOB 218	<b>GİZLİ BASKI MENTEŞE</b> HIDDEN PRESSURE HINGE СКРЫТАЯ ПЕТЛЯ СРЕДНЕГО ПРИЖИМА			-
8	GOB 218-9	<b>GİZLİ BASKI MENTEŞE KARŞILIK</b> HIDDEN PRESSURE HINGE STRIKER ОТВЕТНАЯ ПЛАНКА НЕВИДИМОЙ ПЕТЛИ	9 / 20 mm		-
	GOB 218-13		13 / 20 mm		
9	OVM 217	<b>ORTA BASKI MENTEŞE</b> MIDDLE PRESSURE HINGE ПЕТЛЯ СРЕДНЕГО ПРИЖИМА			-
10	LKI 300-KKI	<b>KKI UYUMLU LEVYE KOL İSPANYOLET</b> DOUBLE SASH GEAR WITH HANDLE SUITABLE FOR KKI ШТУЛЬПОВЫЙ ПРИВОД ПОД МНОГОЗАПОРНЫЙ ЗАМОК			-
11	LPK 415	<b>LEVYE KOL UYUMLU PİM KARŞILIĞI GÜVENLİKLİ</b> PIN STRIKER SUITABLE DOUBLE SASH GEAR WITH HANDLE ОТВЕТКИ ДЛЯ ШТУЛЬПОВОГО ПРИВОДА			-
12	KK 350-9	<b>PİM KARŞILIĞI</b> PIN STRIKER ОТВЕТНАЯ ПЛАНКА			-
	KK 350-13				

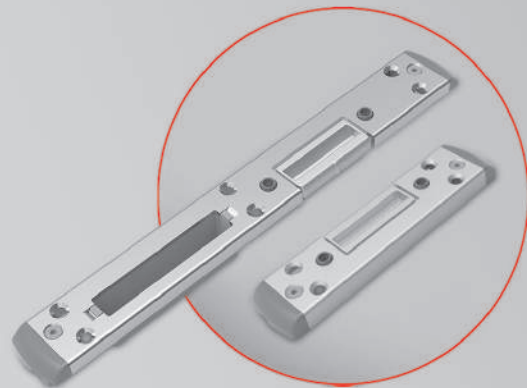



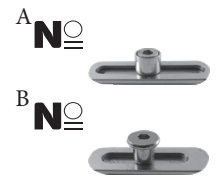

**PLASTİK GÖVDELİ / SINGLE SIDE PLASTIC / ПЛАСТИКОВЫЙ КОРПУС**

A NO	B NO	KİLİTLİ KAPI İSPANOLETİ LOCKABLE DOOR ESPAGNOLETTE ДВЕРНОЙ МНОГО ЗАПОРНЫЙ ЗАМОК				
KKI 250-1	KKI 250-G1		85	25	1600-1800	20
KKI 250-2	KKI 250-G2		85	25	1800-2000	20
KKI 250-3	KKI 250-G3		85	25	2000-2200	20
KKI 28/85-1	KKI 28/85-G1		85	28	1600-1800	20
KKI 28/85-2	KKI 28/85-G2		85	28	1800-2000	20
KKI 28/85-3	KKI 28/85-G3		85	28	2000-2200	20
KKI 350-1	KKI 350-G1		85	35	1600-1800	20
KKI 350-2	KKI 350-G2		85	35	1800-2000	20
KKI 350-3	KKI 350-G3		85	35	2000-2200	20



**PLASTİK GÖVDELİ / SINGLE SIDE PLASTIC / ПЛАСТИКОВЫЙ КОРПУС**

A NO	B NO	KİLİTLİ KAPI İSPANOLETİ ( DİLLİ ) LOCKABLE DOOR ESPAGNOLETTE (WITH BOLT) ДВЕРНОЙ МНОГО ЗАПОРНЫЙ ЗАМОК (С РИГЕЛЕМ)				
KKI DL 250-1	KKI DL 250-G1		85	25	1600-1800	20
KKI DL 250-2	KKI DL 250-G2		85	25	1800-2000	20
KKI DL 250-3	KKI DL 250-G3		85	25	2000-2200	20
KKI DL 28/85-1	KKI DL 28/85-G1		85	28	1600-1800	20
KKI DL 28/85-2	KKI DL 28/85-G2		85	28	1800-2000	20
KKI DL 28/85-3	KKI DL 28/85-G3		85	28	2000-2200	20
KKI DL 350-1	KKI DL 350-G1		85	35	1600-1800	20
KKI DL 350-2	KKI DL 350-G2		85	35	1800-2000	20
KKI DL 350-3	KKI DL 350-G3		85	35	2000-2200	20

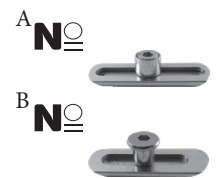

**PLASTİK GÖVDELİ / SINGLE SIDE PLASTIC / ПЛАСТИКОВЫЙ КОРПУС**

A NO	B NO	KİLİTLİ KAPI İSPANOLETİ ( WC - BANYO ) LOCKABLE DOOR ESPAGNOLETTE (WC & BATH) ДВЕРНОЙ МНОГО ЗАПОРНЫЙ ЗАМОК ( WC )				
KKI 260-1	KKI 260-G1		85	25	1600-1800	20
KKI 260-2	KKI 260-G2		85	25	1800-2000	20
KKI 260-3	KKI 260-G3		85	25	2000-2200	20
KKI WC 28/85-1	KKI WC 28/85-G1		85	28	1600-1800	20
KKI WC 28/85-2	KKI WC 28/85-G2		85	28	1800-2000	20
KKI WC 28/85-3	KKI WC 28/85-G3		85	28	2000-2200	20
KKI 360-1	KKI 360-G1		85	35	1600-1800	20
KKI 360-2	KKI 360-G2		85	35	1800-2000	20
KKI 360-3	KKI 360-G3		85	35	2000-2200	20



**PLASTİK GÖVDELİ / SINGLE SIDE PLASTIC / ПЛАСТИКОВЫЙ КОРПУС**

A NO	B NO	KİLİTLİ KAPI İSPANYOLETİ (KESİLEBİLİR) LOCKABLE DOOR ESPAGNOLETTE (CUTTABLE) ДВЕРНОЙ МНОГО ЗАПОРНЫЙ ЗАМОК (ОТРЕЗНОЙ)				
KKI 270-1	KKI 270-G1		85	25	1750-1850	20
KKI 270-2	KKI 270-G2		85	25	1950-2050	20
KKI 270-3	KKI 270-G3		85	25	2150-2250	20
KKI KS 28/85-1	KKI KS 28/85-G1		85	28	1750-1850	20
KKI KS 28/85-2	KKI KS 28/85-G2		85	28	1950-2050	20
KKI KS 28/85-3	KKI KS 28/85-G3		85	28	2150-2250	20
KKI 370-1	KKI 370-G1		85	35	1750-1850	20
KKI 370-2	KKI 370-G2		85	35	1950-2050	20
KKI 370-3	KKI 370-G3		85	35	2150-2250	20



**PLASTİK GÖVDELİ / SINGLE SIDE PLASTIC / ПЛАСТИКОВЫЙ КОРПУС**

A NO	B NO	KİLİTLİ KAPI İSPANYOLETİ (KESİLEBİLİR DİLLİ) LOCKABLE DOOR ESPAGNOLETTE (CUTTABLE WITH BOLT) ДВЕРНОЙ МНОГО ЗАПОРНЫЙ ЗАМОК (ОТРЕЗНОЙ) (С РИГЕЛЕМ)				
KKI DL 270-1	KKI DL 270-G1		85	25	1750-1850	20
KKI DL 270-2	KKI DL 270-G2		85	25	1950-2050	20
KKI DL 270-3	KKI DL 270-G3		85	25	2150-2250	20
KKI KSD 28/85-1	KKI KSD 28/85-G1		85	28	1750-1850	20
KKI KSD 28/85-2	KKI KSD 28/85-G2		85	28	1950-2050	20
KKI KSD 28/85-3	KKI KSD 28/85-G3		85	28	2150-2250	20
KKI DL 370-1	KKI DL 370-G1		85	35	1750-1850	20
KKI DL 370-2	KKI DL 370-G2		85	35	1950-2050	20
KKI DL 370-3	KKI DL 370-G3		85	35	2150-2250	20



**METAL GÖVDELİ / DOUBLE SIDE METAL / МЕТАЛЛИЧЕСКИЙ КОРПУС**

A NO	B NO	KİLİTLİ KAPI İSPANYOLETİ LOCKABLE DOOR ESPAGNOLETTE ДВЕРНОЙ МНОГО ЗАПОРНЫЙ ЗАМОК				
KKI M.2585-1600	KKI M.2585-1600-G		85	25	1600-1800	20
KKI M.2585-1800	KKI M.2585-1800-G		85	25	1800-2000	20
KKI M.2585-2000	KKI M.2585-2000-G		85	25	2000-2200	20
KKI M.3585-1600	KKI M.3585-1600-G		85	35	1600-1800	20
KKI M.3585-1800	KKI M.3585-1800-G		85	35	1800-2000	20
KKI M.3585-2000	KKI M.3585-2000-G		85	35	2000-2200	20
KKI M.2592-1600	KKI M.2592-1600-G		92	25	1600-1800	20
KKI M.2592-1800	KKI M.2592-1800-G		92	25	1800-2000	20
KKI M.2592-2000	KKI M.2592-2000-G		92	25	2000-2200	20
KKI M.3592-1600	KKI M.3592-1600-G		92	35	1600-1800	20
KKI M.3592-1800	KKI M.3592-1800-G		92	35	1800-2000	20
KKI M.3592-2000	KKI M.3592-2000-G		92	35	2000-2200	20



**METAL GÖVDELİ / DOUBLE SIDE METAL / МЕТАЛЛИЧЕСКИЙ КОРПУС**

A NO	B NO	KİLİTLİ KAPI İSPANYOLETİ (DİLLİ) LOCKABLE DOOR ESPAGNOLETTE (WITH BOLT) ДВЕРНОЙ МНОГО ЗАПОРНЫЙ ЗАМОК (С РИГЕЛЕМ)				
KKI M.2585.DL-1600	KKI M.2585.DL-1600-G		85	25	1600-1800	20
KKI M.2585.DL-1800	KKI M.2585.DL-1800-G		85	25	1800-2000	20
KKI M.2585.DL-2000	KKI M.2585.DL-2000-G		85	25	2000-2200	20
KKI M.3585.DL-1600	KKI M.3585.DL-1600-G		85	35	1600-1800	20
KKI M.3585.DL-1800	KKI M.3585.DL-1800-G		85	35	1800-2000	20
KKI M.3585.DL-2000	KKI M.3585.DL-2000-G		85	35	2000-2200	20
KKI M.2592.DL-1600	KKI M.2592.DL-1600-G		92	25	1600-1800	20
KKI M.2592.DL-1800	KKI M.2592.DL-1800-G		92	25	1800-2000	20
KKI M.2592.DL-2000	KKI M.2592.DL-2000-G		92	25	2000-2200	20
KKI M.3592.DL-1600	KKI M.3592.DL-1600-G		92	35	1600-1800	20
KKI M.3592.DL-1800	KKI M.3592.DL-1800-G		92	35	1800-2000	20
KKI M.3592.DL-2000	KKI M.3592.DL-2000-G		92	35	2000-2200	20

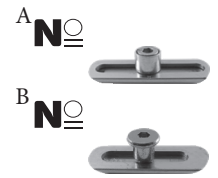

**METAL GÖVDELİ / DOUBLE SIDE METAL / МЕТАЛЛИЧЕСКИЙ КОРПУС**

A NO	B NO	KİLİTLİ KAPI İSPANYOLETİ (KESİLEBİLİR) LOCKABLE DOOR ESPAGNOLETTE (CUTABLE) ДВЕРНОЙ МНОГО ЗАПОРНЫЙ ЗАМОК (ОТРЕЗНОЙ)				
KKI-KES M.2585-1600	KKI-KES M.2585-1600-G		85	25	1750-1850	20
KKI-KES M.2585-1800	KKI-KES M.2585-1800-G		85	25	1950-2050	20
KKI-KES M.2585-2000	KKI-KES M.2585-2000-G		85	25	2150-2250	20
KKI-KES M.3585-1600	KKI-KES M.3585-1600-G		85	35	1750-1850	20
KKI-KES M.3585-1800	KKI-KES M.3585-1800-G		85	35	1950-2050	20
KKI-KES M.3585-2000	KKI-KES M.3585-2000-G		85	35	2150-2250	20
KKI-KES M.2592-1600	KKI-KES M.2592-1600-G		92	25	1750-1850	20
KKI-KES M.2592-1800	KKI-KES M.2592-1800-G		92	25	1950-2050	20
KKI-KES M.2592-2000	KKI-KES M.2592-2000-G		92	25	2150-2250	20
KKI-KES M.3592-1600	KKI-KES M.3592-1600-G		92	35	1750-1850	20
KKI-KES M.3592-1800	KKI-KES M.3592-1800-G		92	35	1950-2050	20
KKI-KES M.3592-2000	KKI-KES M.3592-2000-G		92	35	2150-2250	20

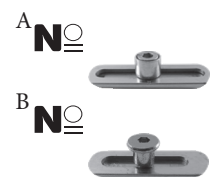
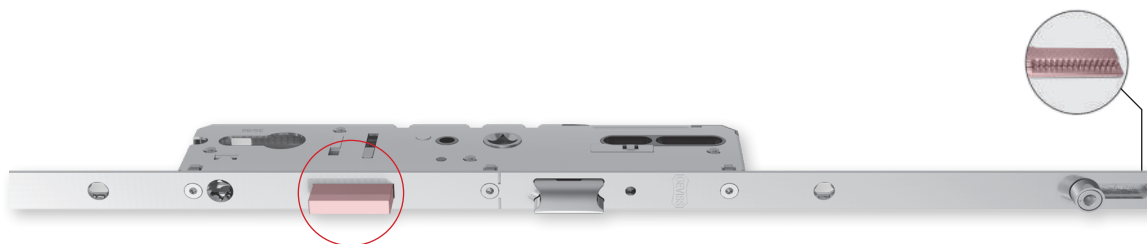

**METAL GÖVDELİ / DOUBLE SIDE METAL / МЕТАЛЛИЧЕСКИЙ КОРПУС**

A NO	B NO	KİLİTLİ KAPI İSPANYOLETİ (KESİLEBİLİR DİLLİ) LOCKABLE DOOR ESPAGNOLETTE (CUTABLE WITH BOLT) ДВЕРНОЙ МНОГО ЗАПОРНЫЙ ЗАМОК (ОТРЕЗНОЙ) (С РИГЕЛЕМ)				
KKI-KES M.2585.DL-1600	KKI-KES M.2585.DL-1600-G		85	25	1750-1850	20
KKI-KES M.2585.DL-1800	KKI-KES M.2585.DL-1800-G		85	25	1950-2050	20
KKI-KES M.2585.DL-2000	KKI-KES M.2585.DL-2000-G		85	25	2150-2250	20
KKI-KES M.3585.DL-1600	KKI-KES M.3585.DL-1600-G		85	35	1750-1850	20
KKI-KES M.3585.DL-1800	KKI-KES M.3585.DL-1800-G		85	35	1950-2050	20
KKI-KES M.3585.DL-2000	KKI-KES M.3585.DL-2000-G		85	35	2150-2250	20
KKI-KES M.2592.DL-1600	KKI-KES M.2592.DL-1600-G		92	25	1750-1850	20
KKI-KES M.2592.DL-1800	KKI-KES M.2592.DL-1800-G		92	25	1950-2050	20
KKI-KES M.2592.DL-2000	KKI-KES M.2592.DL-2000-G		92	25	2150-2250	20
KKI-KES M.3592.DL-1600	KKI-KES M.3592.DL-1600-G		92	35	1750-1850	20
KKI-KES M.3592.DL-1800	KKI-KES M.3592.DL-1800-G		92	35	1950-2050	20
KKI-KES M.3592.DL-2000	KKI-KES M.3592.DL-2000-G		92	35	2150-2250	20

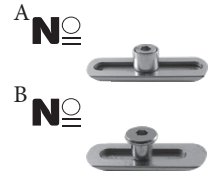

A NO	B NO	KİLİTLİ KAPI İSPANYOLETİ - 967 MM LOCKABLE DOOR ESPAGNOLETTE - 967 MM ДВЕРНОЙ МНОГО ЗАПОРНЫЙ ЗАМОК - 967 MM				
KKI 2585-967	KKI 2585-967 - G		85	25	967	20
KKI 2885-967	KKI 2885-967 - G		85	28	967	20
KKI 3585-967	KKI 3585-967 - G		85	35	967	20

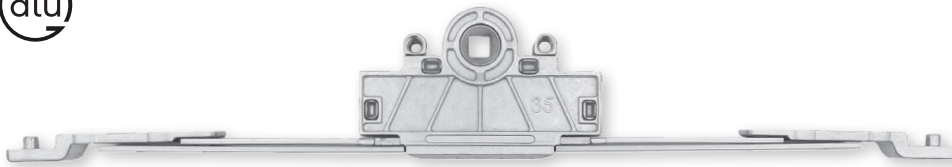

NO	ALÜMİNYUM TİJLİ SİSTEM İSPANYOLET ALUMINIUM ESPAGNOLETTE ПОВОРОТНЫЙ ПРИВОД ДЛЯ АЛЮМИНИЯ			
ALM-ISP-D25		25	-	40
ALM-ISP-D30		30	-	40
ALM-ISP-D35		35	-	40





NO	ALÜMİNYUM - KİLİTLİ KAPI İSPANYOLETİ ( TİJLİ SİSTEM ) MULTIPOINT LOCK FOR ALUMINIUM PROFILES МНОГОЗАПОРНЫЙ ЗАМОК ДЛЯ АЛЮМИНИЯ				
ALM-KKI-25		23	85	25	20
ALM-KKI-28		23	85	28	20
ALM-KKI-35		23	85	35	20



NO	AYARLI KAPI KİLİDİ KARŞILIĞI (ALÜMİNYUM İÇİN) ADJUSTABLE DOOR LOCK STRIKER - FOR ALUMINIUM РЕГУЛИРУЕМАЯ ОТВЕТНАЯ ПЛАНКА (ДЛЯ АЛЮМИНИЕВЫХ ПРОФИЛЕЙ)	
ALM-KK		-



**PLASTİK GÖVDELİ / SINGLE SIDE PLASTIC / ПЛАСТИКОВЫЙ КОРПУС**

<b>NO</b>	<b>PVC SİLİNDİRLİ KAPIL KİLİDİ</b> PVC DOOR LOCK ДВЕРНОЙ ЗАМОК ДЛЯ ПВХ				
KKP 25 100		16	85	25	40
KKP 25 110-WC		16	90	25	40
KKP 28 100		16	85	28	40
KKP 28 110-WC		16	90	28	40
KKP 35 100		16	85	35	40
KKP 35 110-WC		16	90	35	40

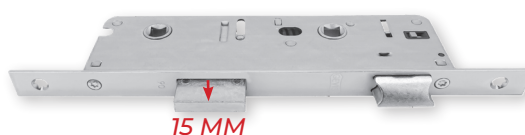
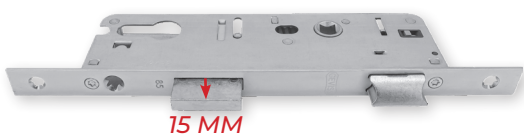

**METAL GÖVDELİ / DOUBLE SIDE METAL / МЕТАЛЛИЧЕСКИЙ КОРПУС**

<b>NO</b>	<b>PVC SİLİNDİRLİ KAPIL KİLİDİ</b> PVC DOOR LOCK ДВЕРНОЙ ЗАМОК ДЛЯ ПВХ				
G.16.2085.15		16	85	20	40
G.16.20WC.15		16	90	20	40
G.16.2092.15		16	92	20	40
G.16.2585.15		16	85	25	40
G.16.25WC.15		16	90	25	40
G.16.2592.15		16	92	25	40
G.16.3085.15		16	85	30	40
G.16.30WC.15		16	90	30	40
G.16.3092.15		16	92	30	40
G.16.3585.15		16	85	35	40
G.16.35WC.15		16	90	35	40
G.16.3592.15		16	92	35	40
G.16.4085.15		16	85	40	40
G.16.40WC.15		16	90	40	40
G.16.4092.15		16	92	40	40

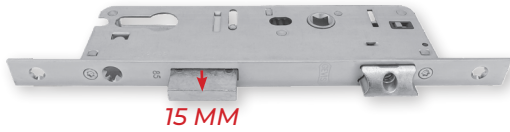



15 MM



15 MM

**METAL GÖVDELİ / DOUBLE SIDE METAL / МЕТАЛЛИЧЕСКИЙ КОРПУС**

	PVC SİLİNDİRLİ KAPI KİLİDİ - ÜST DİL AYARLI PVC DOOR LOCK - ADJUSTABLE TOP LATCH ДВЕРНОЙ ЗАМОК ДЛЯ ПВХ - С РЕГУЛИРУЕМОЙ ЗАЩЕЛКОЙ				
G.16.2085.15AD		16	85	20	40
G.16.20WC.15AD		16	90	20	40
G.16.2092.15AD		16	92	20	40
G.16.2585.15AD		16	85	25	40
G.16.25WC.15AD		16	90	25	40
G.16.2592.15AD		16	92	25	40
G.16.3085.15AD		16	85	30	40
G.16.30WC.15AD		16	90	30	40
G.16.3092.15AD		16	92	30	40
G.16.3585.15AD		16	85	35	40
G.16.35WC.15AD		16	90	35	40
G.16.3592.15AD		16	92	35	40
G.16.4085.15AD		16	85	40	40
G.16.40WC.15AD		16	90	40	40
G.16.4092.15AD		16	92	40	40



10 MM



10 MM

**METAL GÖVDELİ / DOUBLE SIDE METAL / МЕТАЛЛИЧЕСКИЙ КОРПУС**

	PVC SİLİNDİRLİ KAPI KİLİDİ / ALT DİL KISA PVC DOOR LOCK 20/85 - SHORT BOTTOM LATCH ДВЕРНОЙ ЗАМОК ДЛЯ ПВХ 20/85 - С КОРОТКИМ РИГЕЛЕМ				
G.16.2085.10		16	85	20	40
G.16.20WC.10		16	90	20	40
G.16.2092.10		16	92	20	40
G.16.2585.10		16	85	25	40
G.16.25WC.10		16	90	25	40
G.16.2592.10		16	92	25	40
G.16.3085.10		16	85	30	40
G.16.30WC.10		16	90	30	40
G.16.3092.10		16	92	30	40
G.16.3585.10		16	85	35	40
G.16.35WC.10		16	90	35	40
G.16.3592.10		16	92	35	40
G.16.4085.10		16	85	40	40
G.16.40WC.10		16	90	40	40
G.16.4092.10		16	92	40	40

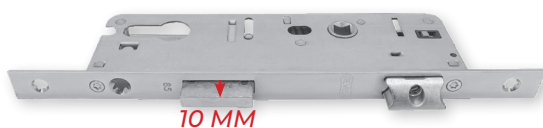

10 MM



10 MM

**METAL GÖVDELİ / DOUBLE SIDE METAL / МЕТАЛЛИЧЕСКИЙ КОРПУС**

NO	PVC SİLİNDİRLİ KAPI KİLİDİ - ÜST DİL AYARLI / ALT DİL KISA PVC DOOR LOCK - ADJUSTABLE TOP LATCH/SHORT BOTTOM LATCH ДВЕРНОЙ ЗАМОК ДЛЯ ПВХ - С РЕГУЛ.ЗАЩЕЛКОЙ И КОРОТКИМ РИГЕЛЕМ				
G.16.2085.10AD		16	85	20	40
G.16.20WC.10AD		16	90	20	40
G.16.2092.10AD		16	92	20	40
G.16.2585.10AD		16	85	25	40
G.16.25WC.10AD		16	90	25	40
G.16.2592.10AD		16	92	25	40
G.16.3085.10AD		16	85	30	40
G.16.30WC.10AD		16	90	30	40
G.16.3092.10AD		16	92	30	40
G.16.3585.10AD		16	85	35	40
G.16.35WC.10AD		16	90	35	40
G.16.3592.10AD		16	92	35	40
G.16.4085.10AD		16	85	40	40
G.16.40WC.10AD		16	90	40	40
G.16.4092.10AD		16	92	40	40

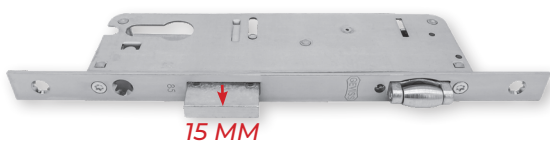

15 MM

**METAL GÖVDELİ / DOUBLE SIDE METAL / МЕТАЛЛИЧЕСКИЙ КОРПУС**

NO	PVC MAKARALI KAPI KİLİDİ PVC DOOR LOCK MM WITH ROLLER LATCH РОЛИКОВЫЙ ЗАМОК ДЛЯ ПВХ				
G.16.20MD.15		16	-	20	40
G.16.25MD.15		16	-	25	40
G.16.30MD.15		16	-	30	40
G.16.35MD.15		16	-	35	40
G.16.40MD.15		16	-	40	40



10 MM

**METAL GÖVDELİ / DOUBLE SIDE METAL / МЕТАЛЛИЧЕСКИЙ КОРПУС**

NO	PVC MAKARALI KAPI KİLİDİ - ALT DİL KISA PVC DOOR LOCK WITH ROLLER LATCH - SHORT BOTTOM LATCH РОЛИКОВЫЙ ЗАМОК ДЛЯ ПВХ - С КОРОТКИМ РИГЕЛЕМ				
G.16.20MD.10		16	-	20	40
G.16.25MD.10		16	-	25	40
G.16.30MD.10		16	-	30	40
G.16.35MD.10		16	-	35	40
G.16.40MD.10		16	-	40	40





15 MM



15 MM

**METAL GÖVDELİ / DOUBLE SIDE METAL / МЕТАЛЛИЧЕСКИЙ КОРПУС**

No	ALÜMİNYUM SİLİNDİRLİ KAPI KİLİDİ ALUMINIUM DOOR LOCK ДВЕРНОЙ ЗАМОК ДЛЯ АЛМ.				
		23	85	20	40
G.23.2085.15		23	85	20	40
G.23.20WC.15		23	90	20	40
G.23.2092.15		23	92	20	40
G.23.2585.15		23	85	25	40
G.23.25WC.15		23	90	25	40
G.23.2592.15		23	92	25	40
G.23.3085.15		23	85	30	40
G.23.30WC.15		23	90	30	40
G.23.3092.15		23	92	30	40
G.23.3585.15		23	85	35	40
G.23.35WC.15		23	90	35	40
G.23.3592.15		23	92	35	40
G.23.4085.15		23	85	40	40
G.23.40WC.15		23	90	40	40
G.23.4092.15		23	92	40	40



15 MM

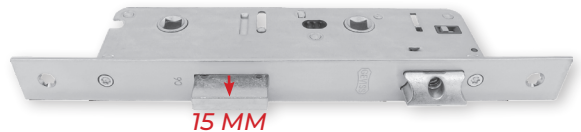

15 MM

**METAL GÖVDELİ / DOUBLE SIDE METAL / МЕТАЛЛИЧЕСКИЙ КОРПУС**

No	ALÜMİNYUM SİLİNDİRLİ KAPI KİLİDİ - ÜST DİL AYARLI ALUMINIUM DOOR LOCK - ADJUSTABLE TOP LATCH ДВЕРНОЙ ЗАМОК ДЛЯ АЛМ. 25/85 - С РЕГУЛИРУЕМОЙ ЗАЩЕЛКОЙ				
		23	85	20	40
G.23.2085.15AD		23	85	20	40
G.23.20WC.15AD		23	90	20	40
G.23.2092.15AD		23	92	20	40
G.23.2585.15AD		23	85	25	40
G.23.25WC.15AD		23	90	25	40
G.23.2592.15AD		23	92	25	40
G.23.3085.15AD		23	85	30	40
G.23.30WC.15AD		23	90	30	40
G.23.3092.15AD		23	92	30	40
G.23.3585.15AD		23	85	35	40
G.23.35WC.15AD		23	90	35	40
G.23.3592.15AD		23	92	35	40
G.23.4085.15AD		23	85	40	40
G.23.40WC.15AD		23	90	40	40
G.23.4092.15AD		23	92	40	40



10 MM



10 MM

**METAL GÖVDELİ / DOUBLE SIDE METAL / МЕТАЛЛИЧЕСКИЙ КОРПУС**

NO	ALÜMİNYUM SİLİNDİRLİ KAPI KİLİDİ - ALT DİL KISA ALU DOOR LOCK - SHORT BOTTOM LATCH ДВЕРНОЙ ЗАМОК ДЛЯ АЛМ. - С КОРОТКИМ РИГЕЛЕМ				
G.23.2085.10		23	85	20	40
G.23.20WC.10		23	90	20	40
G.23.2092.10		23	92	20	40
G.23.2585.10		23	85	25	40
G.23.25WC.10		23	90	25	40
G.23.2592.10		23	92	25	40
G.23.3085.10		23	85	30	40
G.23.30WC.10		23	90	30	40
G.23.3092.10		23	92	30	40
G.23.3585.10		23	85	35	40
G.23.35WC.10		23	90	35	40
G.23.3592.10		23	92	35	40
G.23.4085.10		23	85	40	40
G.23.40WC.10		23	90	40	40
G.23.4092.10		23	92	40	40



10 MM



10 MM





**METAL GÖVDELİ / DOUBLE SIDE METAL / МЕТАЛЛИЧЕСКИЙ КОРПУС**

NO	ALÜMİNYUM SİLİNDİRLİ KAPI KİLİDİ - ÜST DİL AYARLI / ALT DİL KISA ALUMINIUM DOOR LOCK - ADJUSTABLE TOP LATCH/SHORT BOTTOM LATCH ДВЕРНОЙ ЗАМОК ДЛЯ АЛМ. - С РЕГУЛ.ЗАЩЕЛКОЙ И КОРОТКИМ РИГЕЛЕМ				
G.23.2085.10AD		23	85	20	40
G.23.20WC.10AD		23	90	20	40
G.23.2092.10AD		23	92	20	40
G.23.2585.10AD		23	85	25	40
G.23.25WC.10AD		23	90	25	40
G.23.2592.10AD		23	92	25	40
G.23.3085.10AD		23	85	30	40
G.23.30WC.10AD		23	90	30	40
G.23.3092.10AD		23	92	30	40
G.23.3585.10AD		23	85	35	40
G.23.35WC.10AD		23	90	35	40
G.23.3592.10AD		23	92	35	40
G.23.4085.10AD		23	85	40	40
G.23.40WC.10AD		23	90	40	40
G.23.4092.10AD		23	92	40	40



15 MM





## METAL GÖVDELİ / DOUBLE SIDE METAL / МЕТАЛЛИЧЕСКИЙ КОРПУС

№	ALÜMİNYUM MAKARALI KAPI KİLİDİ ALUMINIUM DOOR LOCK WITH ROLLER LATCH РОЛИКОВЫЙ ЗАМОК ДЛЯ АЛМ.				
G.23.20MD.15		23	-	20	40
G.23.25MD.15		23	-	25	40
G.23.30MD.15		23	-	30	40
G.23.35MD.15		23	-	35	40
G.23.40MD.15		23	-	40	40





10 MM

## METAL GÖVDELİ / DOUBLE SIDE METAL / МЕТАЛЛИЧЕСКИЙ КОРПУС

№	ALÜMİNYUM MAKARALI KAPI KİLİDİ - ALT DİL KISA ALU DOOR LOCK WITH ROLLER LATCH - SHORT BOTTOM LATCH РОЛИКОВЫЙ ЗАМОК ДЛЯ АЛМ. - С КОРОТКИМ РИГЕЛЕМ				
G.23.20MD.10		23	-	20	40
G.23.25MD.10		23	-	25	40
G.23.30MD.10		23	-	30	40
G.23.35MD.10		23	-	35	40
G.23.40MD.10		23	-	40	40



№	KKI UYUMLU LEVYE KOL İSPANYOLET DOUBLE SASH GEAR WITH HANDLE SUITABLE FOR KKI ШТУЛЬПОВЫЙ ПРИВОД ПОД МНОГОЗАПОРНЫЙ ЗАМОК		
LKI 300-KKI		1750-2250	10

1

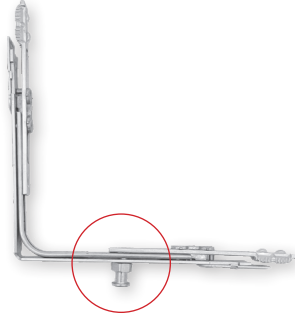

2

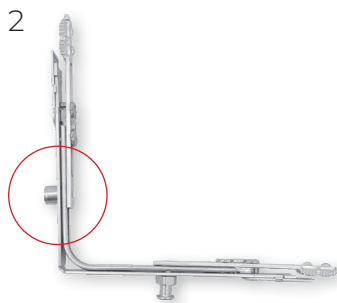

3

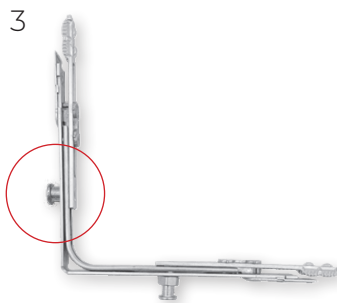

№	KÖŞE DÖNÜŞ HAREKETİ EŞİK PROFİLİNDEN DEVRİLMELİ CORNER TRANSMISSION PART TILTS FROM FRAME PROFILE - STANDARD PIN УГЛОВОЙ ПЕРЕКЛЮЧАТЕЛЬ ДЛЯ АЛЮМИНИЕВОГО ПОРОГА - СТАНДАРТНАЯ ЦАПФА		
1 KDE 313		450 - 2200	40
2 KDE 313-SP		450 - 2200	40
3 KDE 313-GP		450 - 2200	40

1



2



3



	NO	AYARLI KİLİT KARŞILIĞI - KISA ADJUSTABLE LOCKING PLATE - SHORT РЕГУЛИРУЕМАЯ ОТВЕТНАЯ ПЛАНКА РИГЕЛЬНАЯ - КОРОТКАЯ		
1	KK.130.LX-9		9	100
	KK.130.LX-13		13	100
2	KIK 01		-	250
3	KIK 01-M		-	250

1



2



3



4



	NO	AYARLI KİLİT KARŞILIĞI - UZUN ADJUSTABLE LOCKING PLATE - LONG РЕГУЛИРУЕМАЯ ОТВЕТНАЯ ПЛАНКА РИГЕЛЬНАЯ - ДЛИННАЯ		
1	KK.240.LX-R9		9	100
	KK.240.LX-L9		9	100
	KK.240.LX-R13		13	100
	KK.240.LX-L13		13	100
2	KIK 02		-	250
3	KIK 02P		-	200
4	KIK 02-M		-	200

1



2



	NO	ÇİFT KANAT KİLİTLİ İSPANYOLET KARŞILIĞI DOUBLE SASH LOCKABLE ESPAGNOLETTE STRIKER ОТВЕТНАЯ ПЛАНКА ДЛЯ ДВУСВОРЧАТЫХ ДВЕРЕЙ	
1	CKK 02		100
2	LPK 415		100

1

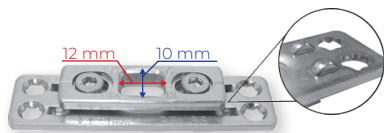

2

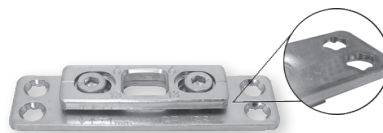

	NO	AYARLI SAC KAPI SÜRGÜ KARŞILIĞI ADJUSTABLE STRIKER FOR DOOR BOLT ( METAL ) РЕГУЛИРУЕМАЯ ОТВЕТНАЯ ПЛАНКА ДВЕРНОГО ШПИНГЛЕТА		
1	CSK-S03B	HOLE DIAMETER : 12,5 mm x 10 mm	9 / 13	100
2	CSK-S04B	HOLE DIAMETER : 12,5 mm x 10 mm	9 / 13	100



<b>NO</b>	<b>ÇİFT KANAT KAPI SÜRGÜ</b> DOUBLE SASH DOOR BOLT ДВЕРНОЙ ШПИНГАЛЕТ ШТУЛЬПА		
SRG-KP3		450-2450	100

1

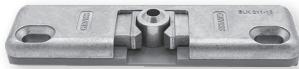

2



<b>NO</b>	<b>BALKON ÇİTÇİTİ</b> BALCONY CLIPS БАЛКОННАЯ ЗАЩЕЛКА		
1	BLK 211-9	9	100
2	BLK 211-13	13	100

**A NO**



**B NO**



ZINC

<b>A NO</b>	<b>B NO</b>	<b>ZAMAK BAREL</b> ZINC CYLINDER ЦИЛИНДР (ЦИНК)	<b>L</b>	
G.BR.ZA.68	G.BR.T.68		68	80
G.BR.ZA.83	G.BR.T.83		83	80
G.BR.ZA.90	G.BR.T.90		90	80
G.BR.ZA.100	G.BR.T.100		100	80

**A NO**



**B NO**



BRASS

<b>A NO</b>	<b>B NO</b>	<b>PİRİNÇ BAREL</b> BRASS CYLINDER ЦИЛИНДР (ЛАТУНЬ)	<b>L</b>	
G.BR.P.68	G.BR.PT.68		68	80
G.BR.P.83	G.BR.PT.83		83	80
G.BR.P.90	G.BR.PT.90		90	80
G.BR.P.100	G.BR.PT.100		100	80

**A** **NO**



90 mm

**B** **NO**

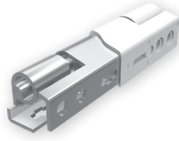

90 mm

**C** **NO**



75 mm

<b>A</b> <b>NO</b>	<b>B</b> <b>NO</b>	<b>C</b> <b>NO</b>	PLASTİK KAPLAMA SAC MENTEŞE STEEL HINGE WITH PLASTIC COVERING МЕТАЛЛО ПЛАСТИКОВАЯ ПЕТЛЯ	RENK COLOR ЦВЕТ	
PME 90.01	PME T90.01	PME 75.01		BEYAZ / WHITE / БЕЛЫЙ RAL 9016	150
PME 90.02	PME T90.02	PME 75.02		ALTINMEŞE / GOLDEN OAK / ЗОЛОТОЙ ДУБ RAL 8003	150
PME 90.03	PME T90.03	PME 75.03		KOYU KAHVE / DARK BROWN / ТЁМНОКОРИЧНЕВЫЙ RAL 8019	150
PME 90.RA	PME T90.RA	PME 75.RA		ÖZEL RENK / PRIVATE COLOR / ЦВЕТ НА ЗАКАЗ	150

**A** **NO**



75 mm

**B** **NO**



75 mm

ECO

<b>A</b> <b>NO</b>	<b>B</b> <b>NO</b>	ZAMAK MENTEŞE ZINC HINGE ЦИНКОВАЯ ПЕТЛЯ	RENK COLOR ЦВЕТ	
G.ZM75.01	G.ZM75.01E		BEYAZ / WHITE / БЕЛЫЙ RAL 9016	200
G.ZM75.02	G.ZM75.02E		ALTINMEŞE / GOLDEN OAK / ЗОЛОТОЙ ДУБ RAL 8003	200
G.ZM75.03	G.ZM75.03E		KOYU KAHVE / DARK BROWN / ТЁМНОКОРИЧНЕВЫЙ RAL 8019	200
G.ZM75.RA	G.ZM75.ERA		ÖZEL RENK / PRIVATE COLOR / ЦВЕТ НА ЗАКАЗ	200

**A** **NO**



95 mm

**B** **NO**



100 mm

<b>A</b> <b>NO</b>	<b>B</b> <b>NO</b>	ZAMAK MENTEŞE ZINC HINGE ЦИНКОВАЯ ПЕТЛЯ	RENK COLOR ЦВЕТ	
G.ZM95.01	G.ZM100.01		BEYAZ / WHITE / БЕЛЫЙ RAL 9016	150
G.ZM95.02	G.ZM100.02		ALTINMEŞE / GOLDEN OAK / ЗОЛОТОЙ ДУБ RAL 8003	150
G.ZM95.03	G.ZM100.03		KOYU KAHVE / DARK BROWN / ТЁМНОКОРИЧНЕВЫЙ RAL 8019	150
G.ZM95.RA	G.ZM100.RA		ÖZEL RENK / PRIVATE COLOR / ЦВЕТ НА ЗАКАЗ	150

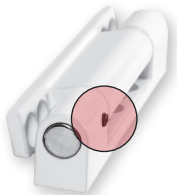

100 mm

<b>NO</b>	ZAMAK MENTEŞE DIŞA AÇILIM ZINC HINGE OUTWARD OPENING ПЕТЛЯ ДЛЯ ОТКРЫВАНИЯ НАРУЖУ	RENK COLOR ЦВЕТ	
G.ZM100D.01		BEYAZ / WHITE / БЕЛЫЙ RAL 9016	150
G.ZM100D.02		ALTINMEŞE / GOLDEN OAK / СВЕТЛОКОРИЧНЕВЫЙ RAL 8003	150
G.ZM100D.03		KOYU KAHVE / DARK BROWN / ТЁМНОКОРИЧНЕВЫЙ RAL 8019	150
G.ZM100D.RA		ÖZEL RENK / PRIVATE COLOR / ЦВЕТ НА ЗАКАЗ	150

**A**  
**N**



160 KG

ZINC

**B**  
**N**



ALUMINIUM

**C**  
**N**



ZINC

<b>A</b> <b>N</b>	<b>B</b> <b>N</b>	<b>C</b> <b>N</b>	3D MENTEŞELER 3D HINGES 3D ДВЕРНЫЕ ПЕТЛИ	RENK COLOR ЦВЕТ	
3DM 160.01	3DM 105.01	3DM 108.01		BEYAZ / WHITE / БЕЛЫЙ	24
3DM 160.02	3DM 105.02	3DM 108.02		ALTINMEŞE / GOLDEN OAK / СВЕТЛОКОРИЧНЕВЫЙ	24
3DM 160.03	3DM 105.03	3DM 108.03		KOYU KAHVE / DARK BROWN / ТЁМНОКОРИЧНЕВЫЙ	24
3DM 160.RA	3DM 105.RA	3DM 108.RA		ÖZEL RENK / PRIVATE COLOR / ЦВЕТ НА ЗАКАЗ	24

**A**  
**N**

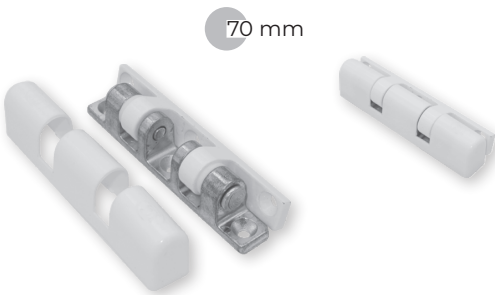

70 mm

**B**  
**N**

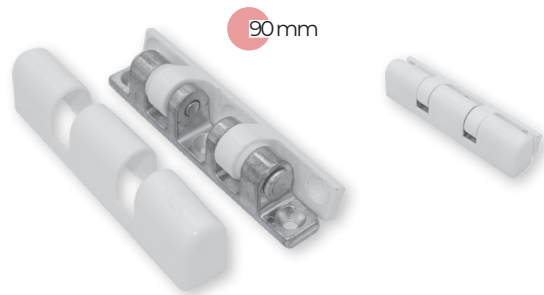

90 mm

<b>A</b> <b>N</b>	<b>B</b> <b>N</b>	TAK PRATİK MENTEŞE EASY PLUG-IN HINGE ПЕТЛЯ ПРАКТИЧЕСКАЯ	RENK COLOR ЦВЕТ	
ZME T70.01	ZME T90.01		BEYAZ / WHITE / БЕЛЫЙ	200
ZME T70.02	ZME T90.02		ALTINMEŞE / GOLDEN OAK / СВЕТЛОКОРИЧНЕВЫЙ	200
ZME T70.03	ZME T90.03		KOYU KAHVE / DARK BROWN / ТЁМНОКОРИЧНЕВЫЙ	200
ZME T70.RA	ZME T90.RA		ÖZEL RENK / PRIVATE COLOR / ЦВЕТ НА ЗАКАЗ	200

**A**  
**N**



M 6

**B**  
**N**



M 7

<b>A</b> <b>N</b>	<b>B</b> <b>N</b>	PIPO MENTEŞE PIPO HINGE ПЕТЛЯ - PIPO	RENK COLOR ЦВЕТ	
PIM6 01	PIM7 01		BEYAZ / WHITE / БЕЛЫЙ	250
PIM6 02	PIM7 02		ALTINMEŞE / GOLDEN OAK / СВЕТЛОКОРИЧНЕВЫЙ	250
PIM6 03	PIM7 03		KOYU KAHVE / DARK BROWN / ТЁМНОКОРИЧНЕВЫЙ	250
PIM6 RA	PIM7 RA		ÖZEL RENK / PRIVATE COLOR / ЦВЕТ НА ЗАКАЗ	250

**1**

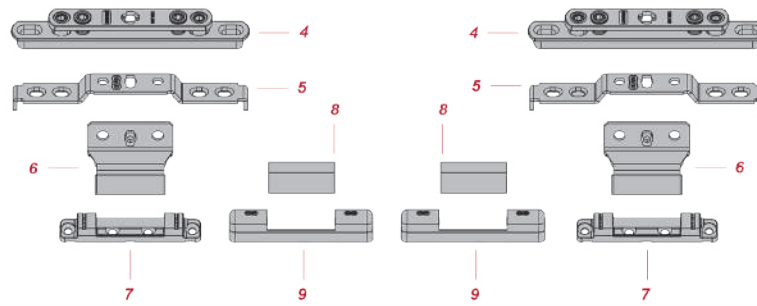
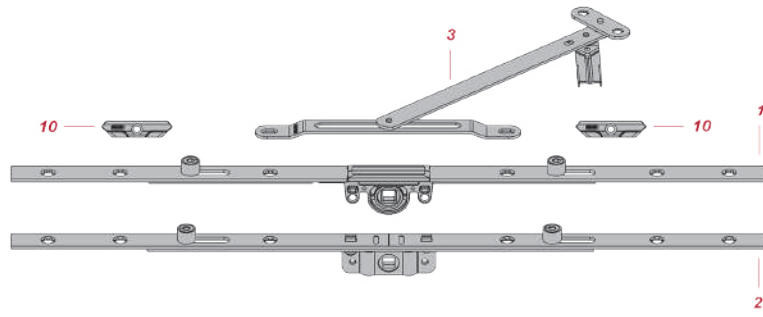

**2**

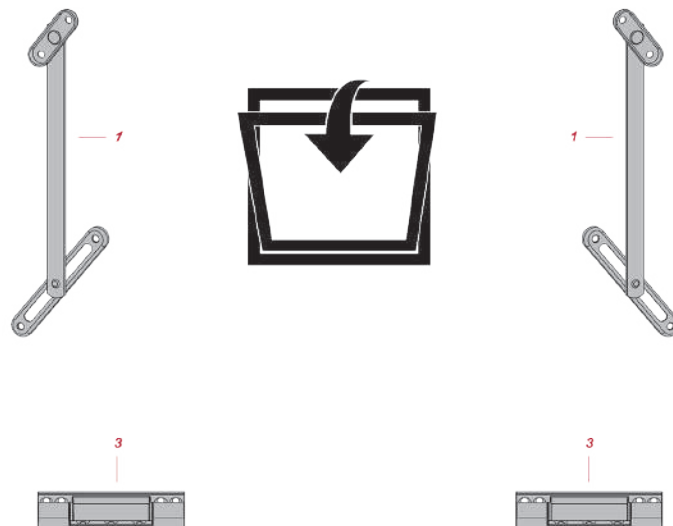
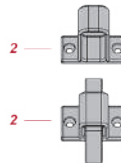



1

	<b>NO</b>	<b>ÜRÜN ADI</b> PRODUCT NAME НАИМЕНОВАНИЕ			
1	İSP Z165 İSP Z300 İSP Z400 İSP Z600 İSP Z800 İSP Z1000 İSP Z1200 İSP Z1400 İSP Z1600 İSP Z1800 İSP Z2000 İSP Z2200	<b>TEK AÇILIM İSPANYOLET ZAMAK GÖBEK</b> SIDE HUNG ESPAGNOLETTE ZINC HOUSING ПРИВОД ПОВОРОТНЫЙ ( ЦИНК )	KYO-ZG 15.5 mm		
	165-250 250-400 400-600 600-800 800-1000 1000-1200 1200-1400 1400-1600 1600-1800 1800-2000 2000-2200 2200-2400				
	2	İSP M300 İSP M400 İSP M600 İSP M800 İSP M1000 İSP M1200 İSP M1400 İSP M1600 İSP M1800 İSP M2000 İSP M2200	<b>TEK AÇILIM İSPANYOLET METAL GÖBEK</b> SIDE HUNG ESPAGNOLETTE METAL HOUSING ПРИВОД ПОВОРОТНЫЙ ( МЕТАЛ )	KYO-ZG 15.5 mm	
		250-400 400-600 600-800 800-1000 1000-1200 1200-1400 1400-1600 1600-1800 1800-2000 2000-2200 2200-2400			
		3	VMK 504	<b>VASİSTAS MAKAS</b> TRANSFORM SCISSOR ОГРАНИЧИТЕЛЬ ФРАМУГИ	-
		4	OMA 308	<b>AYARLI ORTA MENTEŞE</b> ADJUSTABLE MIDDLE HINGE СРЕДНЯЯ ПЕТЛЯ РЕГУЛИРУЕМАЯ	-
		5	ORM 208	<b>ORTA MENTEŞE</b> MIDDLE HINGE ПОВОРОТНАЯ СРЕДНЯЯ ПЕТЛЯ	-
		6	KNM 737-9	<b>KANAT MENTEŞE</b> T&T STAY HINGES КРОНШТЕЙН ВЕРХНИЙ	9/20 mm
			KNM 737-13		13/20 mm
		7	KSM 720	<b>KASA MENTEŞE</b> T&T STAY ARM BEARING ПЕТЛЯ РАМЫ ВЕРХНЯЯ	-
		8	PK KNM	<b>KANAT MENTEŞE KAPAK</b> SASH HINGE COVER ДЕКОР НАКЛАДКА ВЕРХНЕГО КРОНШТЕЙНА	-
9		PK KSMN	<b>KASA MENTEŞE KAPAK</b> FRAME HINGE COVER ДЕКОР НАКЛАДКА ВЕРХНЕЙ ПЕТЛИ РАМЫ	-	

2

	<b>NO</b>	<b>ÜRÜN ADI</b> PRODUCT NAME НАИМЕНОВАНИЕ	
1	VMK 13	<b>VASİSTAS MAKASI</b> TRANSFORM SCISSOR ОГРАНИЧИТЕЛЬ ФРАМУГИ	13 mm
	VMK 22		22 mm
2	VAC 01	<b>VASİSTAS ÇARPMA</b> TRANSFORM WINDOW STRIKER ЗАЩЕЛКА ДЛЯ ФРАМУГИ	-
3	PME 90	<b>90 MM PLASTİK KAPLAMA SAC MENTEŞE</b> 90 MM STEEL HINGE WITH PLASTIC COVERING	WITH NAIL
	PME T90		

1



2



<b>NO</b>		<b>ORTA MENTEŞE</b> MIDDLE HINGE ПОВОРОТНАЯ СРЕДНЯЯ ПЕТЛЯ	
1	OMA 308	<b>AYARLI</b> - ADJUSTABLE - РЕГУЛИРУЕМАЯ	50
2	ORM 208		100

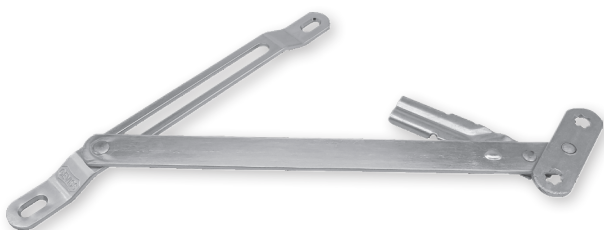

<b>NO</b>		<b>VASİSTAS MAKASI</b> TRANSORM SCISSOR ОГРАНИЧИТЕЛЬ ФРАМУГИ	
VMK 504			100

**A NO**



13 mm

**B NO**



22 mm

<b>A NO</b>	<b>B NO</b>	<b>VASİSTAS MAKASI</b> TRANSORM SCISSOR ОГРАНИЧИТЕЛЬ ФРАМУГИ	<b>RENK</b> COLOR ЦВЕТ	
VMK 13-01	VMK 22-01		<b>BEYAZ</b> / WHITE / БЕЛЫЙ RAL 9016	<b>A: 400 / B: 300</b>
VMK 13-02	VMK 22-02		<b>ALTINMEŞE</b> / GOLDEN OAK / ЗОЛОТОЙ ДУБ RAL 8003	<b>A: 400 / B: 300</b>
VMK 13-03	VMK 22-03		<b>KOYU KAHVE</b> / DARK BROWN / ТЕМНОКОРИЧНЕВЫЙ RAL 8019	<b>A: 400 / B: 300</b>
VMK 13-RA	VMK 22-RA		<b>ÖZEL RENK</b> / PRIVATE COLOR / ЦВЕТ НА ЗАКАЗ	<b>A: 400 / B: 300</b>



<b>NO</b>		<b>VASİSTAS ÇARPMA</b> TRANSORM WINDOW STRIKER ЗАЩЁЛКА ДЛЯ ФРАМУГИ	
VAC 01			600

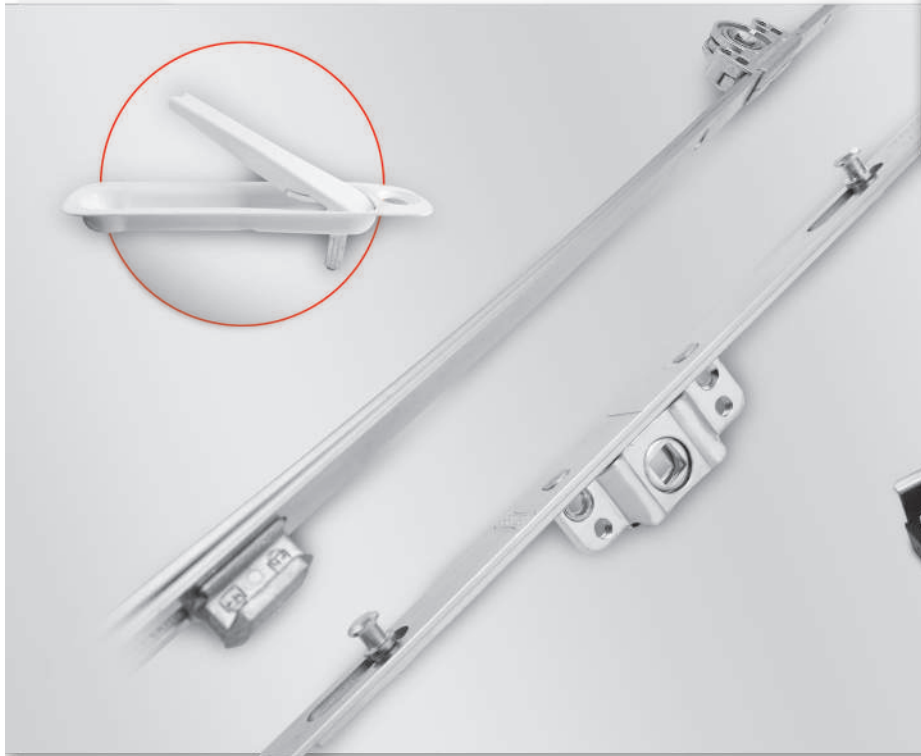
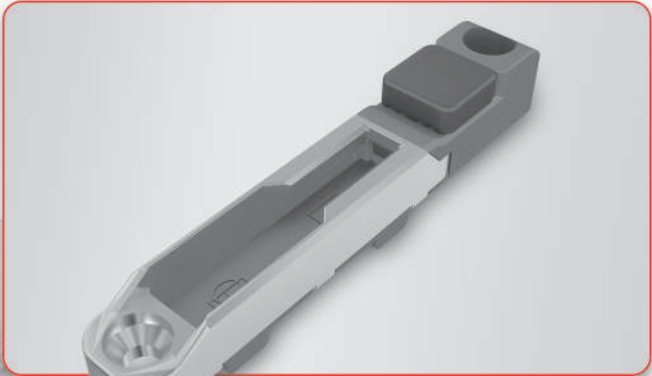
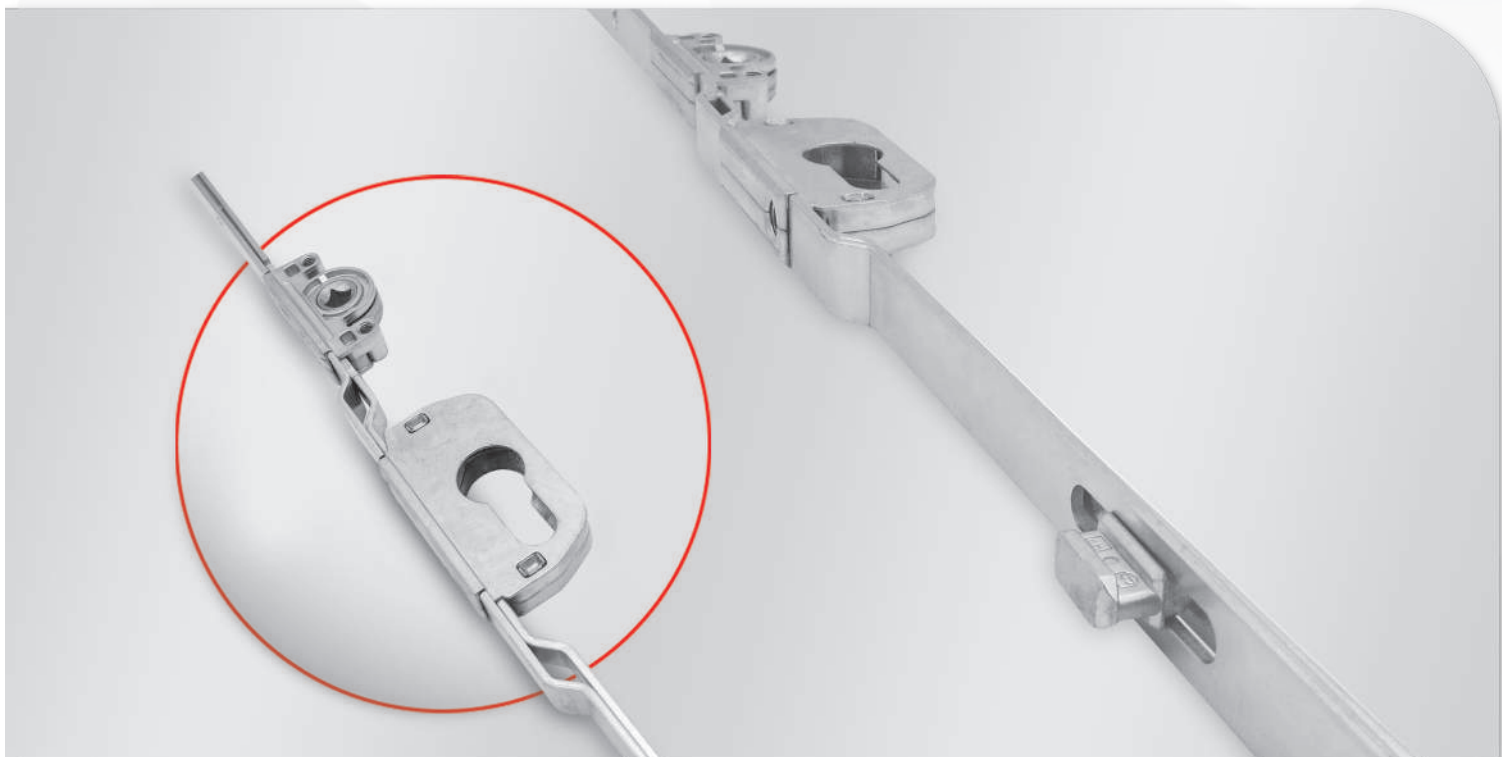

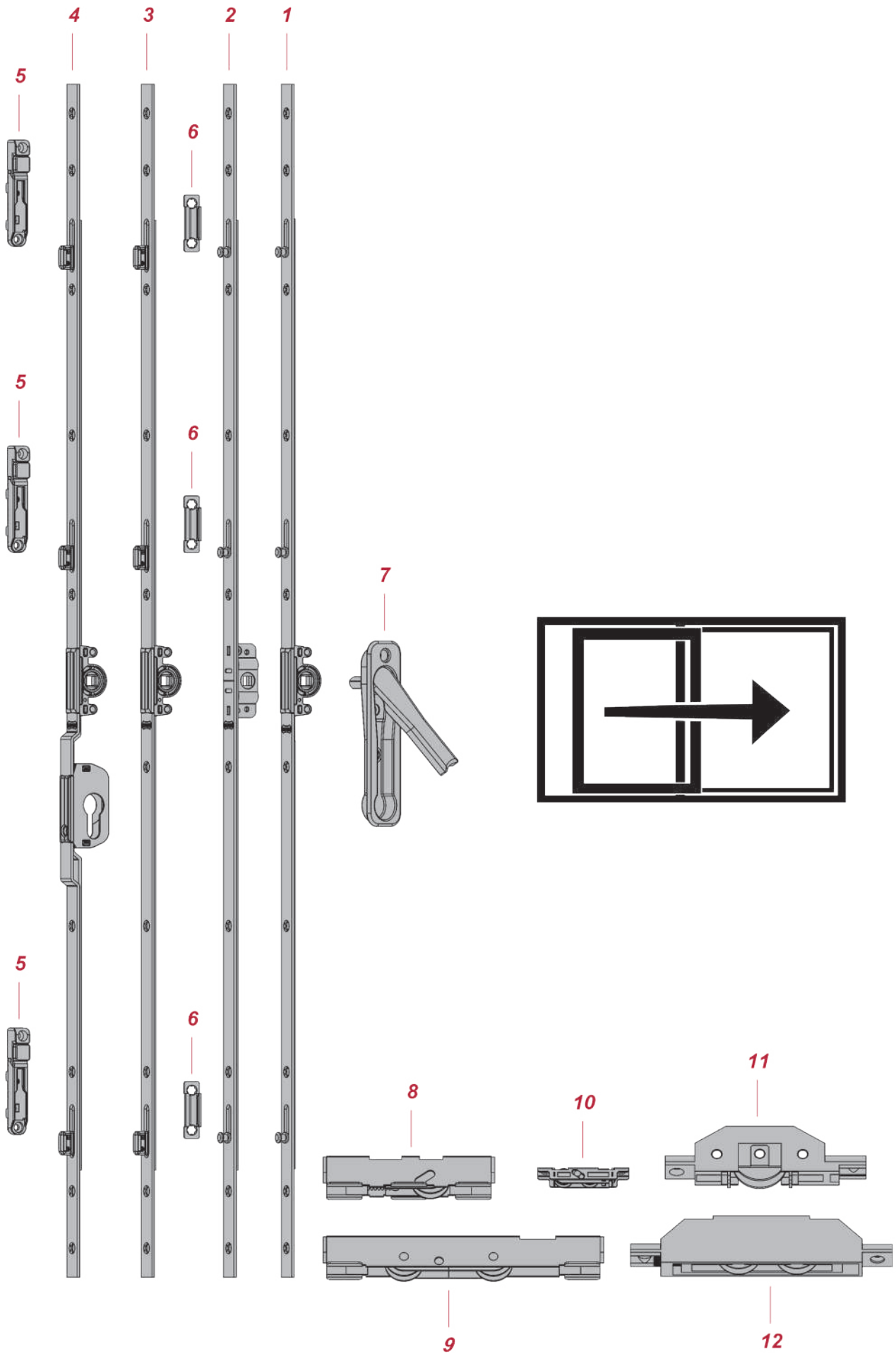

	<b>NO</b>	ÜRÜN ADI PRODUCT NAME НАИМЕНОВАНИЕ		
1	İSP Z300 - SUR / 15	<b>SÜRME İSPANYOLET ZAMAK GÖBEK</b> SLIDING ESPAGNOLETTE ZINC HOUSING РАЗДВИЖНОЙ ПРИВОД - ЦИНК	<b>KYO-ZG</b> <b>15.5 mm</b>	250-400
	İSP Z400 - SUR / 15			400-600
	İSP Z600 - SUR / 15			600-800
	İSP Z800 - SUR / 15			800-1000
	İSP Z1000 - SUR / 15			1000-1200
	İSP Z1200 - SUR / 15			1200-1400
	İSP Z1400 - SUR / 15			1400-1600
	İSP Z1600 - SUR / 15			1600-1800
	İSP Z1800 - SUR / 15			1800-2000
	İSP Z2000 - SUR / 15			2000-2200
İSP Z2200 - SUR / 15	2200-2400			
2	İSP M300 - SUR / 15	<b>SÜRME İSPANYOLET METAL GÖBEK</b> SLIDING ESPAGNOLETTE METAL HOUSING РАЗДВИЖНОЙ ПРИВОД - МЕТАЛЛ	<b>KYO-ZG</b> <b>15.5 mm</b>	250-400
	İSP M400 - SUR / 15			400-600
	İSP M600 - SUR / 15			600-800
	İSP M800 - SUR / 15			800-1000
	İSP M1000 - SUR / 15			1000-1200
	İSP M1200 - SUR / 15			1200-1400
	İSP M1400 - SUR / 15			1400-1600
	İSP M1600 - SUR / 15			1600-1800
	İSP M1800 - SUR / 15			1800-2000
	İSP M2000 - SUR / 15			2000-2200
İSP M2200 - SUR / 15	2200-2400			
3	ISP Z300 - ZSUR / 15	<b>SÜRME İSPANYOLET ZAMAK GÖBEK ZAMAK PİMLİ</b> SLIDING ESPAGNOLETTE ZINC HOUSING - ZINC PIVOT РАЗДВИЖНОЙ ПРИВОД - ЦАПФА ЦИНК	<b>KYO-ZG</b> <b>15.5 mm</b>	250-400
	ISP Z400 - ZSUR / 15			400-600
	ISP Z600 - ZSUR / 15			600-800
	ISP Z800 - ZSUR / 15			800-1000
	ISP Z1000 - ZSUR / 15			1000-1200
	ISP Z1200 - ZSUR / 15			1200-1400
	ISP Z1400 - ZSUR / 15			1400-1600
	ISP Z1600 - ZSUR / 15			1600-1800
	ISP Z1800 - ZSUR / 15			1800-2000
	ISP Z2000 - ZSUR / 15			2000-2200
ISP Z2200 - ZSUR / 15	2200-2400			
4	ISP BRL 1600/SUR - ZP	<b>SÜRME İSPANYOLET BARELLİ ZAMAK PİMLİ</b> LOCKABLE SLIDING ESPAGNOLETTE ZINC PIVOT РАЗДВИЖНОЙ ПРИВОД С ЗАПОРМ - ЦАПФА ЦИНК	<b>KYO-ZG</b> <b>15.5 mm</b>	1600-1800
	ISP BRL 1800/SUR - ZP			1800-2000
	ISP BRL 2000/SUR - ZP		<b>92 mm</b>	2000-2200
5	SRK Z100	<b>ZAMAK SÜRME KARŞILIK</b> ZINC SLIDING STRIKER ОТВЕТНАЯ ПЛАНКА ДЛЯ РАЗДВИЖНОГО ПРИВОДА С ЦАПФОЙ ЦИНК		-
6	ISK 01	<b>İSPANYOLET SÜRME SAC KARŞILIĞI</b> SLIDING ESPAGNOLETTE STRIKER ОТВЕТНАЯ ПЛАНКА ДЛЯ РАЗДВИЖНЫХ ПРИВОДОВ	<b>WITH NAIL</b>	-
	ISK 02			-
7	GZK GAK GAK.08	<b>SÜRME GİZLİ KOL</b> SLIDING HANDLE СКРЫТАЯ РУЧКА ДЛЯ РАЗДВИЖНОЙ СИСТЕМЫ	<b>ZINC</b> <b>ALUMINIUM</b> <b>ALUMINIUM</b>	-
8	G.STS.IPLY	<b>SÜRME TEKER</b> SLIDING WHEEL РОЛИК ДЛЯ РАЗДВИЖКИ	<b>BRASS</b>	-
	G.STS.PLY		<b>POLYAMID</b>	-
9	G.BCS.PRN	<b>SÜRME TEKER ÇİFTLİ</b> SLIDING DOUBLE WHEEL РОЛИК ДЛЯ РАЗДВИЖКИ	<b>BRASS</b>	-
	G.BCS.PLY		<b>POLYAMID</b>	-
10	G.CST.KRM	<b>KÜÇÜK SÜRME ÇİFTLİ TEKERLEK</b> SLIDING DOUBLE WHEEL - SMALL РОЛИК ДЛЯ РАЗДВИЖКИ - МАЛЫЙ	<b>METAL</b>	-
11	G.BST.PRN	<b>SÜRME TEKER</b> SLIDING WHEEL РОЛИК ДЛЯ РАЗДВИЖКИ	<b>BRASS</b>	-
	G.BST.PLY		<b>POLYAMID</b>	-
12	G.SRL.TK	<b>SÜRME TEKER ÇİFTLİ</b> SLIDING DOUBLE WHEEL РОЛИК ДЛЯ РАЗДВИЖКИ		-

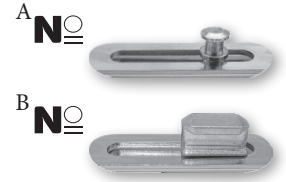
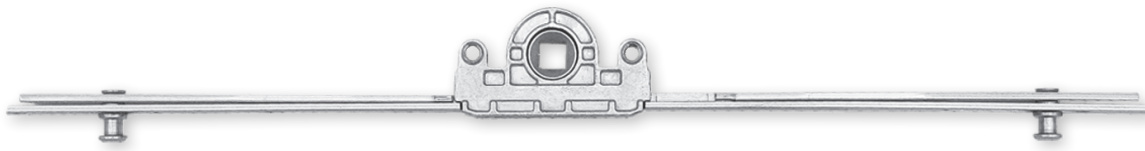

A NO	B NO	SÜRME İSPANYOLET ZAMAK GÖBEK SLIDING ESPAGNOLETTE ZINC HOUSING РАЗДВИЖНОЙ ПРИВОД - ЦИНК			
ISP Z300-SUR / 15	ISP Z300-ZSUR / 15		15,5	250-400	20
ISP Z400-SUR / 15	ISP Z400-ZSUR / 15		15,5	400-600	20
ISP Z600-SUR / 15	ISP Z600-ZSUR / 15		15,5	600-800	20
ISP Z800-SUR / 15	ISP Z800-ZSUR / 15		15,5	800-1000	20
ISP Z1000-SUR / 15	ISP Z1000-ZSUR / 15		15,5	1000-1200	20
ISP Z1200-SUR / 15	ISP Z1200-ZSUR / 15		15,5	1200-1400	20
ISP Z1400-SUR / 15	ISP Z1400-ZSUR / 15		15,5	1400-1600	20
ISP Z1600-SUR / 15	ISP Z1600-ZSUR / 15		15,5	1600-1800	20
ISP Z1800-SUR / 15	ISP Z1800-ZSUR / 15		15,5	1800-2000	20
ISP Z2000-SUR / 15	ISP Z2000-ZSUR / 15		15,5	2000-2200	20
ISP Z2200-SUR / 15	ISP Z2200-ZSUR / 15		15,5	2200-2400	20

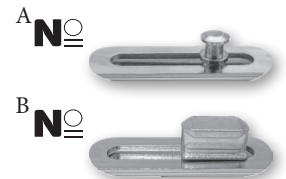

A NO	B NO	SÜRME İSPANYOLET ZAMAK GÖBEK SLIDING ESPAGNOLETTE ZINC HOUSING РАЗДВИЖНОЙ ПРИВОД - ЦИНК			
ISP Z400-SUR / 7,5	ISP Z400-ZSUR / 7,5		7,5	395-595	20
ISP Z600-SUR / 7,5	ISP Z600-ZSUR / 7,5		7,5	595-795	20
ISP Z800-SUR / 7,5	ISP Z800-ZSUR / 7,5		7,5	795-995	20
ISP Z1000-SUR / 7,5	ISP Z1000-ZSUR / 7,5		7,5	995-1195	20
ISP Z1200-SUR / 7,5	ISP Z1200-ZSUR / 7,5		7,5	1195-1395	20
ISP Z1400-SUR / 7,5	ISP Z1400-ZSUR / 7,5		7,5	1395-1595	20
ISP Z1600-SUR / 7,5	ISP Z1600-ZSUR / 7,5		7,5	1595-1795	20
ISP Z1800-SUR / 7,5	ISP Z1800-ZSUR / 7,5		7,5	1795-1995	20
ISP Z2000-SUR / 7,5	ISP Z2000-ZSUR / 7,5		7,5	1995-2195	20
ISP Z2200-SUR / 7,5	ISP Z2200-ZSUR / 7,5		7,5	2195-2395	20

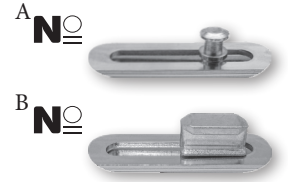
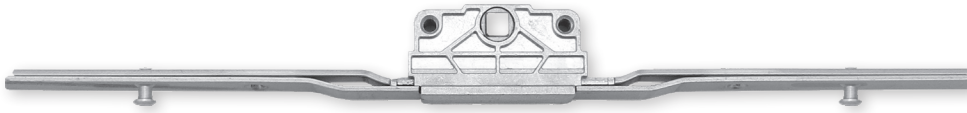

A NO	B NO	SÜRME İSPANYOLET ZAMAK GÖBEK SLIDING ESPAGNOLETTE ZINC HOUSING РАЗДВИЖНОЙ ПРИВОД - ЦИНК			
ISP Z300-SUR / 19.5	ISP Z300-ZSUR / 19.5		19.5	250-400	20
ISP Z400-SUR / 19.5	ISP Z400-ZSUR / 19.5		19.5	400-600	20
ISP Z600-SUR / 19.5	ISP Z600-ZSUR / 19.5		19.5	600-800	20
ISP Z800-SUR / 19.5	ISP Z800-ZSUR / 19.5		19.5	800-1000	20
ISP Z1000-SUR / 19.5	ISP Z1000-ZSUR / 19.5		19.5	1000-1200	20
ISP Z1200-SUR / 19.5	ISP Z1200-ZSUR / 19.5		19.5	1200-1400	20
ISP Z1400-SUR / 19.5	ISP Z1400-ZSUR / 19.5		19.5	1400-1600	20
ISP Z1600-SUR / 19.5	ISP Z1600-ZSUR / 19.5		19.5	1600-1800	20
ISP Z1800-SUR / 19.5	ISP Z1800-ZSUR / 19.5		19.5	1800-2000	20
ISP Z2000-SUR / 19.5	ISP Z2000-ZSUR / 19.5		19.5	2000-2200	20
ISP Z2200-SUR / 19.5	ISP Z2200-ZSUR / 19.5		19.5	2200-2400	20

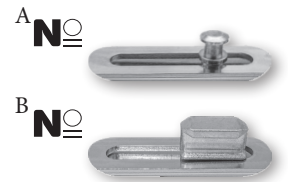

A NO	B NO	SÜRME İSPANYOLET ZAMAK GÖBEK SLIDING ESPAGNOLETTE ZINC HOUSING РАЗДВИЖНОЙ ПРИВОД - ЦИНК			
ISP Z300-SUR / 22	ISP Z300-ZSUR / 22		22	250-400	20
ISP Z400-SUR / 22	ISP Z400-ZSUR / 22		22	400-600	20
ISP Z600-SUR / 22	ISP Z600-ZSUR / 22		22	600-800	20
ISP Z800-SUR / 22	ISP Z800-ZSUR / 22		22	800-1000	20
ISP Z1000-SUR / 22	ISP Z1000-ZSUR / 22		22	1000-1200	20
ISP Z1200-SUR / 22	ISP Z1200-ZSUR / 22		22	1200-1400	20
ISP Z1400-SUR / 22	ISP Z1400-ZSUR / 22		22	1400-1600	20
ISP Z1600-SUR / 22	ISP Z1600-ZSUR / 22		22	1600-1800	20
ISP Z1800-SUR / 22	ISP Z1800-ZSUR / 22		22	1800-2000	20
ISP Z2000-SUR / 22	ISP Z2000-ZSUR / 22		22	2000-2200	20
ISP Z2200-SUR / 22	ISP Z2200-ZSUR / 22		22	2200-2400	20

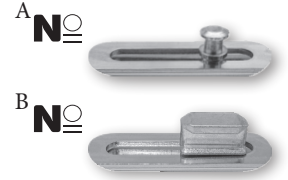
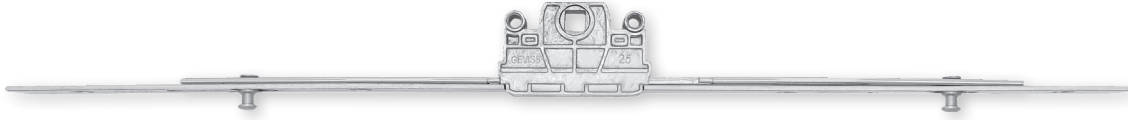

A NO	B NO	SÜRME İSPANYOLET ZAMAK GÖBEK SLIDING ESPAGNOLETTE ZINC HOUSING РАЗДВИЖНОЙ ПРИВОД - ЦИНК			
ISP Z300-SUR / 25	ISP Z300-ZSUR / 25		25	250-400	15
ISP Z400-SUR / 25	ISP Z400-ZSUR / 25		25	400-600	15
ISP Z600-SUR / 25	ISP Z600-ZSUR / 25		25	600-800	15
ISP Z800-SUR / 25	ISP Z800-ZSUR / 25		25	800-1000	15
ISP Z1000-SUR / 25	ISP Z1000-ZSUR / 25		25	1000-1200	15
ISP Z1200-SUR / 25	ISP Z1200-ZSUR / 25		25	1200-1400	15
ISP Z1400-SUR / 25	ISP Z1400-ZSUR / 25		25	1400-1600	15
ISP Z1600-SUR / 25	ISP Z1600-ZSUR / 25		25	1600-1800	15
ISP Z1800-SUR / 25	ISP Z1800-ZSUR / 25		25	1800-2000	15
ISP Z2000-SUR / 25	ISP Z2000-ZSUR / 25		25	2000-2200	15
ISP Z2200-SUR / 25	ISP Z2200-ZSUR / 25		25	2200-2400	15

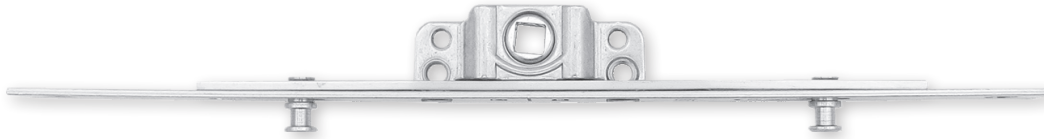

NO	SÜRME İSPANYOLET METAL GÖBEK SLIDING ESPAGNOLETTE METAL HOUSING РАЗДВИЖНОЙ ПРИВОД - МЕТАЛЛ			
ISP M300 - SUR / 15		15,5	250-400	20
ISP M400 - SUR / 15		15,5	400-600	20
ISP M600 - SUR / 15		15,5	600-800	20
ISP M800 - SUR / 15		15,5	800-1000	20
ISP M1000 - SUR / 15		15,5	1000-1200	20
ISP M1200 - SUR / 15		15,5	1200-1400	20
ISP M1400 - SUR / 15		15,5	1400-1600	20
ISP M1600 - SUR / 15		15,5	1600-1800	20
ISP M1800 - SUR / 15		15,5	1800-2000	20
ISP M2000 - SUR / 15		15,5	2000-2200	20

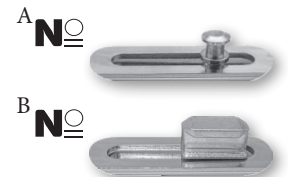

A NO	B NO	KİLİTLİ SÜRME İSPANYOLET - BAREL YERİ ALTTA LOCKABLE SLIDING ESPAGNOLETTE - CYLINDER ON TOP РАЗДВИЖНОЙ ПРИВОД С ЗАПОРОМ				
ISP BRL 1600/SUR	ISP BRL 1600/SUR - ZP		92	15,5	1600-1800	20
ISP BRL 1800/SUR	ISP BRL 1800/SUR - ZP		92	15,5	1800-2000	20
ISP BRL 2000/SUR	ISP BRL 2000/SUR - ZP		92	15,5	2000-2200	20



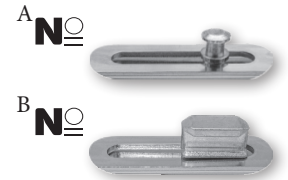

A NO	B NO	KİLİTLİ SÜRME İSPANYOLET - BAREL YERİ ÜSTTE LOCKABLE SLIDING ESPAGNOLETTE - CYLINDER ON BOTTOM РАЗДВИЖНОЙ ПРИВОД С ЗАПОРОМ				
ISP BRL 1600/SUR - U	ISP BRL 1600/SUR - U - ZP		180	15,5	1600-1800	20
ISP BRL 1800/SUR - U	ISP BRL 1800/SUR - U - ZP		180	15,5	1800-2000	20
ISP BRL 2000/SUR - U	ISP BRL 2000/SUR - U - ZP		180	15,5	2000-2200	20

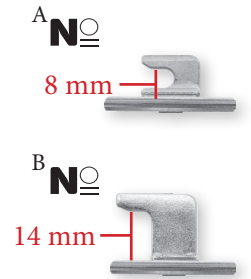

A NO	B NO	SÜRME İSPANYOLET KANCA PİMLİ (ALUMİNYUM SİSTEME UYGUN) TPR ESPAGNOLETTE РАЗДВИЖНОЙ ПРИВОД С КРЮЧКОВИДНОЙ ЦАПФОЙ (ДЛЯ АЛЮМИНИЕВЫХ СИСТЕМ)			
ISP Z300-ASUR	ISP Z300-ASUR - U		15.5	250-400	20
ISP Z400-ASUR	ISP Z400-ASUR - U		15.5	400-600	20
ISP Z600-ASUR	ISP Z600-ASUR - U		15.5	600-800	20
ISP Z800-ASUR	ISP Z800-ASUR - U		15.5	800-1000	20
ISP Z1000-ASUR	ISP Z1000-ASUR - U		15.5	1000-1200	20
ISP Z1200-ASUR	ISP Z1200-ASUR - U		15.5	1200-1400	20
ISP Z1400-ASUR	ISP Z1400-ASUR - U		15.5	1400-1600	20
ISP Z1600-ASUR	ISP Z1600-ASUR - U		15.5	1600-1800	20
ISP Z1800-ASUR	ISP Z1800-ASUR - U		15.5	1800-2000	20
ISP Z2000-ASUR	ISP Z2000-ASUR - U		15.5	2000-2200	20



A NO	B NO	C NO	SÜRME GİZLİ KOL SLIDING SHEET HANDLE СКРЫТАЯ РУЧКА ДЛЯ РАЗДВИЖНОЙ СИСТЕМЫ	RENK COLOR ЦВЕТ	
GZK 01	GAK 01	GAK.8 01		BEYAZ / WHITE / БЕЛЫЙ	100
GZK 02	GAK 02	GAK.8 02		ALTINMEŞE / GOLDEN OAK / СВЕТЛОКОРИЧНЕВЫЙ	100
GZK 03	GAK 03	GAK.8 03		KOYU KAHVE / DARK BROWN / ТЕМНОКОРИЧНЕВЫЙ	100
GZK RA	GAK RA	GAK.8 RA		ÖZEL RENK / PRIVATE COLOR / ЦВЕТ НА ЗАКАЗ	100

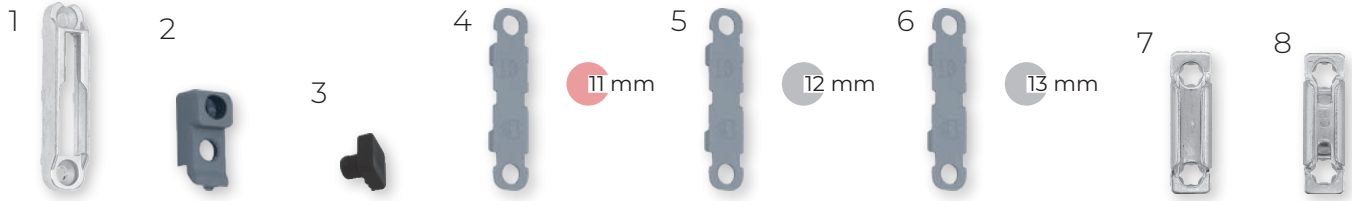

NO		SÜRME KARŞILIKLAR SLIDING PIVOT STRIKER ОТВЕТНЫЕ ПЛАНКИ ДЛЯ РАЗДВИЖНЫХ ПРИВODOB	
1	SRK Z100		100
2	SRK C200		500
3	SRK E300		500
4	SRK T11		500
5	SRK T12		500
6	SRK T13		500
7	ISK 01		1000
8	ISK 02		1000

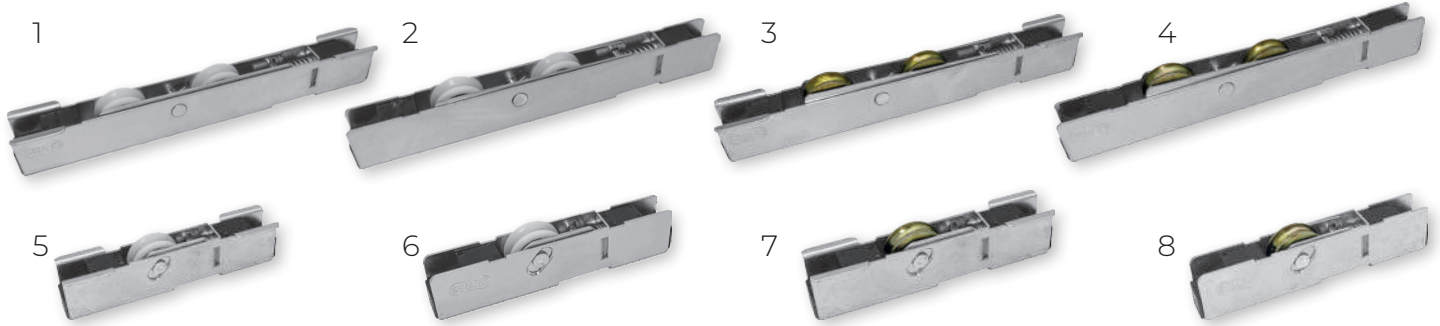

NO		SÜRME TEKERLER SLIDING WHEELS РОЛИК ДЛЯ РАЗДВИЖНЫХ СИСТЕМ	
1	G.BCS.PLY	Sürme Teker Çiftli Polyamid - Sac	170
2	G.BCS.PLY.01	Sürme Teker Çiftli Kulaksız Polyamid - Sac	170
3	G.BCS.PRN	Sürme Teker Çiftli Piriç - Sac	150
4	G.BCS.PRN.01	Sürme Teker Çiftli Kulaksız Piriç - Sac	150
5	G.STS.PLY	Sürme Teker Tekli Polyamid - Sac	120
6	G.STS.PLY.01	Sürme Teker Tekli Kulaksız Polyamid - Sac	120
7	G.STS.IPLY	Sürme Teker Tekli Piriç - Sac	120
8	G.STS.IPLY.01	Sürme Teker Tekli Kulaksız Piriç - Sac	120



NO		SÜRME TEKERLER SLIDING WHEELS РОЛИК ДЛЯ РАЗДВИЖНЫХ СИСТЕМ	
1	G.BST.PLY	Büyük Sürme Polyamid Teker - Zamak	100
2	G.BST.PRN	Büyük Sürme Piriç Teker - Zamak	100
3	G.CST.KRM	Küçük Sürme Çiftli Tekerlek - Sac	180
4	G.SRL.TK	Sürme Çiftli Tekerlek - Zamak	100
5	SIN.RUL.12/42	Sürme Sineklik Tekerlek	1000



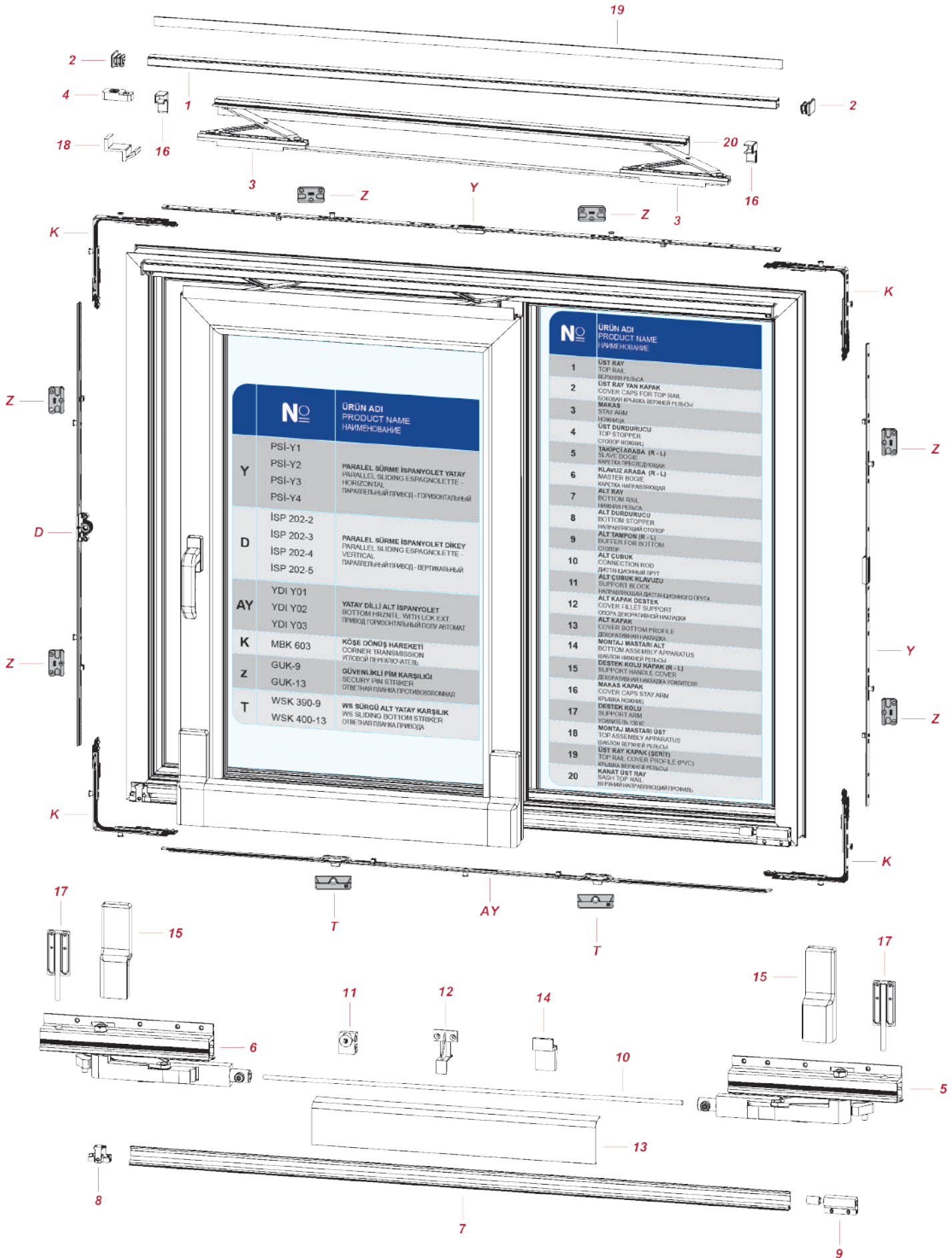

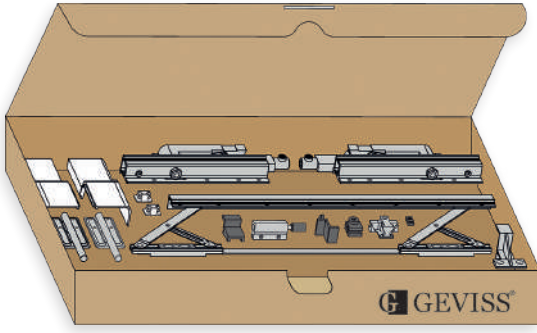

N <sub>0</sub>	N <sub>0</sub>	N <sub>0</sub>	N <sub>0</sub>	PARALEL SÜRME SİSTEMİ PARALLEL SLIDING SYSTEM ПАРАЛЛЕЛЬНО-РАЗДВИЖНАЯ СИСТЕМА	RENK COLOR ЦВЕТ	
WS-20.01	WS-25.01	WS-30.01	WS-35.01		BEYAZ / WHITE / БЕЛЫЙ	1
WS-20.02	WS-25.02	WS-30.02	WS-35.02		ALTINMEŞE (DESENLİ) / GOLDEN OAK (PATTERNED) / ЗОЛОТОЙ ДУБ	1
WS-20.03	WS-25.03	WS-30.03	WS-35.03		KOYU KAHVE / DARK BROWN / ТЕМНОКОРИЧНЕВЫЙ	1
WS-20.04	WS-25.04	WS-30.04	WS-35.04		GÜMÜŞ / SILVER / СЕРЕБРО	1



A N <sub>0</sub>	B N <sub>0</sub>	YATAY DİLLİ İSPANYOLET HORIZONTAL ESPAGNOLETTE WITH BOLT ПРИВОД ГОРИЗОНТАЛЬНЫЙ ПОЛУАВТОМАТ		
YDİ Y01	-		600-1100	10
YDİ Y02	YDİ Y02-G		900-1400	10
YDİ Y03	YDİ Y03-G		1300-1800	10



A N <sub>0</sub>	B N <sub>0</sub>	PARALEL SÜRME İSPANYOLET PARALLEL SLIDING ESPAGNOLETTE ПАРАЛЛЕЛЬНЫЕ ПРИВОДА		
PSİ-Y1	PSİ-Y1/G		700-1200	10
PSİ-Y2	PSİ-Y2/G		900-1400	10
PSİ-Y3	PSİ-Y3/G		1200-1700	10
PSİ-Y4	PSİ-Y4/G		1700-2200	10

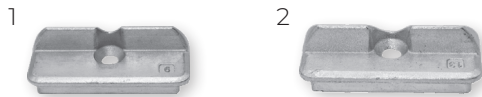

N <sub>0</sub>	WS SÜRGÜ ALT YATAY KARŞILIK SEMI-AUTOMATIC SLIDING SYSTEM NOTTOM STRIKER ОТВЕТНЫЕ ПЛАНКА ГОРИЗОНТАЛЬНОГО ПРИВОДА		
1 WSK 390-9		9	100
2 WSK 400-13		13	100

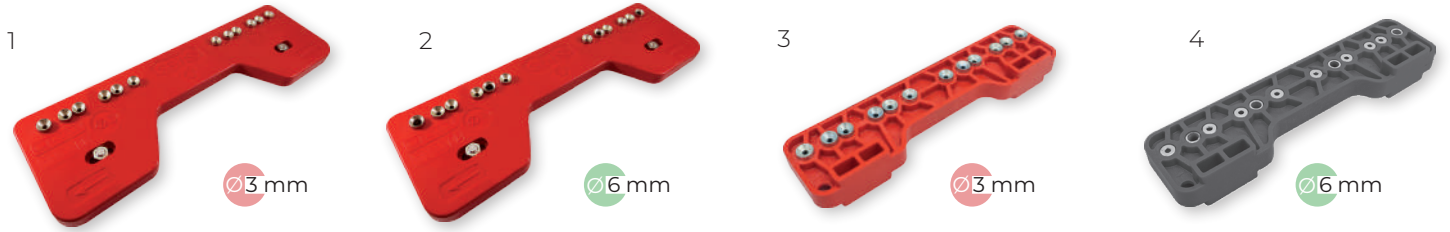

NO		SABİT MAFSAL & KASA MENTEŞE DELİK ŞABLONU CORNER BEARING AND HINGE HOLE TEMPLATE МОНТАЖНЫЙ ШАБЛОН РАМЫ	
1	KSM 1550	3 mm	5
2	KSM 1600	6 mm	5
3	KSM.EKO 1400	3 mm	5
4	KSM.EKO 1420	6 mm	5



NO		HAREKETLİ MAFSAL DELİK ŞABLONU DRILL IN CORNER HINGE HOLE TEMPLATE МОНТАЖНЫЙ ШАБЛОН СТВОРКИ	
1	KNM 1650	3 mm	5
2	KNM 1700	6 mm	5



NO		PLASTİK KAPLAMALI 90° LİK SAC MENTEŞE DELİK ŞABLONU STEEL HINGE WITH PLASTIC COVERING-DRILL TEMPLATE МОНТАЖНЫЙ ШАБЛОН ДЛЯ МЕТАЛЛОПЛАСТИКОВОЙ ПЕТЛИ	
PME TMP			1





NO		GÜVENLİK KİLİDİ DELİK ŞABLONU WINDOW SECURITY LOCK DRILL TEMPLATE МОНТАЖНЫЙ ШАБЛОН ЗАМКА БЕЗОПАСНОСТИ	
KS 100			1

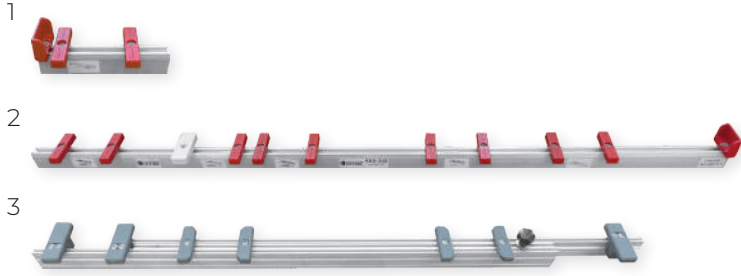

NO		3D MENTEŞE ŞABLONU 3D HINGE MONTAGE TEMPLATE МОНТАЖНЫЙ ШАБЛОН 3D ДВЕРНОЙ ПЕТЛИ	
3DM.TEMP			1



	<b>NO</b>	<b>SERİ MONTAJ ŞABLONU UYGULAMA</b> SERIAL MONTAGE APPLICATION МОНТАЖНЫЙ ШАБЛОН			
1	KKS 50	NIGHT VENTILATION STRIKER	-	-	1
2	KKS 100	ESPAGNOLETES	-	700 - 1400	1
	KKS 150	ESPAGNOLETES	-	1200 - 2200	1
3	KKS 200	STAY ARMS	600 - 1350	-	1
	KKS 300	MIDDLE LOCK (VERTICAL)	-	-800 - 2200	1
	KKS 350	MIDDLE LOCK (HORIZONTAL)	-800 - 2200	-	1



	<b>NO</b>	<b>ÇİFT AÇILIM KURMA &amp; MENTEŞE PİMİ ÇIKARTMA KOLU</b> TILT AND TURN INITIAL SETAP & HINGE PIVOT EXTRACTION HANDLE МОНТАЖНАЯ РУЧКА СРЫВА И КЛЮЧЬ ДЛЯ ШТЫРЯ ПЕТЛИ РАМЫ	
	CK-AP1		1



	<b>NO</b>	<b>4 MM ALYAN ANAHTARI</b> 4 MM ALLEN KEY ШЕСТИГРАННЫЙ КЛЮЧ (4 MM)	
	ALY-2500-1		5

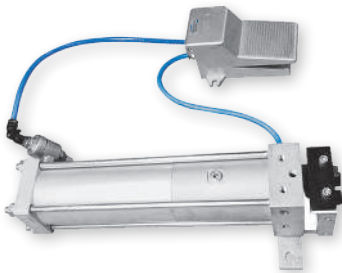

	<b>NO</b>	<b>İSPANYOLET KESME PRESİ</b> ESPAGNOLETTE CUTTING MACHINE ПРЕС ДЛЯ РЕЗКИ ПРИВОДОВ	
	IKP 3718		1



NO		ALÜMİNYUM KOLLAR ALUMINIUM HANDLES АЛЮМИНИЕВЫЕ РУЧКИ			
1	APK 770	ALÜMİNYUM PENCERE KOLU / ALUMINIUM WINDOW HANDLES / АЛЮМИНИЕВАЯ РУЧКА ОКОННАЯ	-	-	100
2	APK 780	ALÜMİNYUM YAYLI KAPI KOLLARI / ALUMINIUM DOOR HANDLES WITH SPRING / АЛЮМИНИЕВАЯ ДВЕРНАЯ РУЧКА С ПРУЖИНКОЙ	25 / 28 / 35	85	40
3	APK 790	ALÜMİNYUM YAYLI KAPI KOLLARI - WC / ALUMINIUM DOOR HANDLES WITH SPRING - WC / АЛЮМИНИЕВАЯ ДВЕРНАЯ РУЧКА (WC)	25 / 28 / 35	90	40



NO		ALÜMİNYUM PENCERE KOLLARI ALUMINIUM WINDOW HANDLES АЛЮМИНИЕВАЯ РУЧКА ОКОННАЯ	
1	APK 950	EGE - ANKA SERIES	100
2	APK 775	MILANO SERIES	100
3	APK 800	BELGRAD SERIES	100
4	APK 880	ATLAS SERIES	100



NO		KİLİTLİ KOLLAR HANDLES WITH KEY РУЧКИ С ЗАМКОМ	
1	AKK T770	ALÜMİNYUM KİLİTLİ KOL - TEKLİ / ALUMINIUM HANDLE WITH KEY - SINGLE / АЛЮМИНИЕВАЯ РУЧКА С КЛЮЧОМ - ОДНОСТОРОННЯЯ	80
2	AKK T740	ZAMAK KİLİTLİ KOL - TEKLİ / ZINC HANDLE WITH KEY - SINGLE / ЦИНКОВАЯ РУЧКА С КЛЮЧОМ - ОДНОСТОРОННЯЯ	80
3	AKK S770	ALÜMİNYUM KİLİTLİ KOL - ÇİFTLİ / ALUMINIUM HANDLE WITH KEY - DOUBLE / АЛЮМИНИЕВАЯ РУЧКА С КЛЮЧОМ - ДВУСТОРОННЯЯ	40
4	AKK S740	ZAMAK KİLİTLİ KOL - TEKLİ / ZINC HANDLE WITH KEY - SINGLE / ЦИНКОВАЯ РУЧКА С КЛЮЧОМ - ДВУСТОРОННЯЯ	40



1





2



3





 <b>PLASTİK PENCERE KOLLARI</b> PVC HANDLES FOR WINDOW ПЛАСТИКОВЫЕ ОКОННЫЕ РУЧКИ		
1	PPK 740	<b>PENCERE KOLU - EKO</b> / PVC HANDLE FOR WINDOW - ECO / ОКОННАЯ РУЧКА - ЭКО 200
2	PPK 750	<b>PENCERE KOLU - DEMİRSİZ</b> / PVC HANDLE FOR WINDOW - NOT ANCHORED / ПЛАСТИКОВАЯ РУЧКА С КОРОТКИМ СТЕРЖНЕМ 200
3	PPK 760	<b>PENCERE KOLU - DEMİRLİ</b> / PVC HANDLE FOR WINDOW - ANCHORED / ПЛАСТИКОВАЯ РУЧКА С ДЛИННЫМ СТЕРЖНЕМ 200

1



2



 <b>PLASTİK KAPI KOLLARI</b> PVC HANDLES FOR DOOR ПЛАСТИКОВЫЕ ДВЕРНЫЕ РУЧКИ		
1	PPK 770	<b>PLASTİK KAPI KOLU</b> / PVC HANDLES FOR DOOR / ПЛАСТИКОВАЯ ДВЕРНАЯ РУЧКА 40
2	PPK 780	<b>PLASTİK KAPI KOLU WC</b> / PVC HANDLES FOR WC DOOR / WC ПЛАСТИКОВАЯ ДВЕРНАЯ РУЧКА 40

1





2



3



 <b>ALÜMİNYUM KOLLAR</b> ALUMINIUM HANDLES АЛЮМИНИЕВЫЕ РУЧКИ		
1	APK SDK.02	<b>SÜRME D KOL</b> / SLIDING D HANDLE / РАЗДВИЖНАЯ РУЧКА ТИПА "D" 10
2	APK SDK.01	<b>SÜRME D KOL</b> / SLIDING D HANDLE / РАЗДВИЖНАЯ РУЧКА ТИПА "D" 10
3	APK 900	ZERO SERIES 100

A **NO**



B **NO**



A <b>NO</b>	B <b>NO</b>	ISICAM PROFİLİ SPACER BARS ДИСТАНЦИОННАЯ РАМКА	A mm	B mm	
G.GP.SSB.6MM	G.GP.BSB.6MM		5,5 mm	6 mm	1500 mt
G.GP.SSB.9MM	G.GP.BSB.9MM		8,5 mm	9 mm	1500 mt
G.GP.SSB.10MM	G.GP.BSB.10MM		9,5 mm	10 mm	1500 mt
G.GP.SSB.11MM	G.GP.BSB.11MM		10,5 mm	11 mm	1000 mt
G.GP.SSB.12MM	G.GP.BSB.12MM		11,5 mm	12 mm	1000 mt
G.GP.SSB.14MM	G.GP.BSB.14MM		13,5 mm	14 mm	750 mt
G.GP.SSB.15MM	G.GP.BSB.15MM		14,5 mm	15 mm	750 mt
G.GP.SSB.16MM	G.GP.BSB.16MM		15,5 mm	16 mm	750 mt
G.GP.SSB.20MM	G.GP.BSB.20MM		19,5 mm	20 mm	500 mt
G.GP.SSB.24MM	G.GP.BSB.24MM		23,5 mm	24 mm	500 mt



<b>NO</b>	TİYAKOL A+B BİLEŞENLİ TIYACOL A+B COMPONENT ТИАКОЛЬ А+В КОМПОНЕНТ	
G.GP.TH01	A : 30 / B : 3	1
G.GP.TH02	A : 80 / B : 8	1
G.GP.TH03	A : 331 / B : 36	1

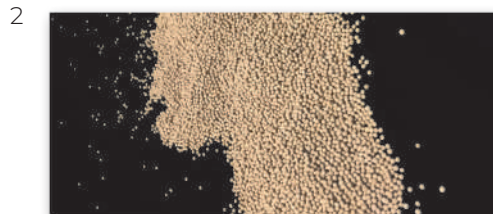

<b>NO</b>	SAM MALZEMELERİ GLASS MATERIALS МАТЕРИАЛЫ ДЛЯ СТЕЛОПАКЕТА	
1 G.GP.HTM	HOTMELT / HOTMELT / ТЕРМОКЛЕЙ	1
2 G.GP.NEM.02	NEM ALICI / DEHUMIDIFIER FUGAMOL / МАЛЕКУЛЯРНОЕ СИТО	1
3 G.GP.BTY	BUTİL / BUTYL / БУТИЛ	1



<b>№</b>	<b>KÖŞE KLİPSİ</b> CORNER CLIPS УГЛОВЫЕ КЛИПСЫ	<b>mm</b>	
G.GP.BES.55		6 mm	5000
G.GP.BES.85		9 mm	10000
G.GP.BES.95		10 mm	10000
G.GP.BES.105		11 mm	10000
G.GP.BES.115		12 mm	10000
G.GP.BES.135		14 mm	5000
G.GP.BES.145		15 mm	5000
G.GP.BES.155		16 mm	5000
G.GP.BES.195		20 mm	5000
G.GP.BES.235		24 mm	2500

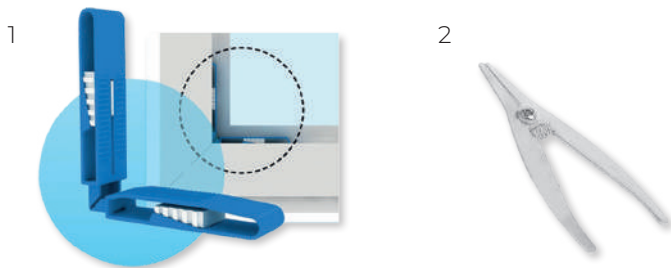

<b>№</b>	<b>AYARLI CAM TAKOZU</b> ADJUSTABLE GLASS WEDGE РЕГУЛИРУЕМАЯ ПОДКЛАДКА ПОД СТЕКЛОПАКЕТ	<b>mm</b>	
G.ACT.18		18 mm	500
G.ACT.24		24 mm	400
1 G.ACT.28		28 mm	400
G.ACT.32		32 mm	300
G.ACT.42		42 mm	250
2 TM USS CTM	<b>CAM TAKOZU MAKASI</b> / GLASS WEDGE SCISSOR / НОЖНИЦЫ ДЛЯ РЕГУЛИРОВКИ ПОДКЛАДКИ	-	20



<b>№</b>	<b>CAM TAKOZU</b> GLASS WEDGE ПОДКЛАДКА ПОД СТЕКЛОПАКЕТ	<b>mm</b>	
1 G.ACT.1019	<b>CAM TAKOZU</b> / GLASS WEDGE / ПОДКЛАДКА ПОД СТЕКЛОПАКЕТ	2x25x80	15000
2 G.ACT.1020	<b>CAM TAKOZU</b> / GLASS WEDGE / ПОДКЛАДКА ПОД СТЕКЛОПАКЕТ	3x25x80	10000
3 G.ACT.1021	<b>CAM TAKOZU</b> / GLASS WEDGE / ПОДКЛАДКА ПОД СТЕКЛОПАКЕТ	5x25x80	10000
4 G.ACT.1022	<b>CAM TAKOZU</b> / GLASS WEDGE / ПОДКЛАДКА ПОД СТЕКЛОПАКЕТ	2x28x80	15000
5 G.ACT.1023	<b>CAM TAKOZU</b> / GLASS WEDGE / ПОДКЛАДКА ПОД СТЕКЛОПАКЕТ	3x28x80	10000
6 G.ACT.1024	<b>CAM TAKOZU</b> / GLASS WEDGE / ПОДКЛАДКА ПОД СТЕКЛОПАКЕТ	5x28x80	10000



NO	ORTA KAYIT BAĞLANTI TAKOZLARI MULLION CONNECTORS СОЕДИНИТЕЛИ ИМПОСТОВ	
OKBT	PROFİLLERE GÖRE TALEP EDİNİZ ASK BY PROFILE BRAND ЗАПРАШИВАЙТЕ ПО ВИДУ ПРОФИЛЕЙ	0



NO	PLASTİK AKSESUARLAR PLASTIC ACCESSORIES ПЛАСТИКОВЫЕ АКССУАРЫ	
1	G.TAP-0 <b>SU TAHLİYE TAPASI GENEL / MONTAGE PLUG GENERAL / ЗАГЛУШКА ВОДОУТЛИВА</b>	40000
1	G.TAP-1 <b>SU TAHLİYE TAPASI ABS / MONTAGE PLUG ABS / ЗАГЛУШКА ВОДОУТЛИВА ABS</b>	25000
2	G.BUL.TAP-0 <b>BULDEKS (TORK) VİDA TAPASI / MONTAGE PLUG FOR / ЗАГЛУШКА МОНТАЖНОГО САМОРЕЗА</b>	60000
3	G.MON.TAP-0 <b>MONTAJ TAPASI 10 mm / MONTAGE PLUG 10 mm / МОНТАЖНАЯ ЗАГЛУШКА 10MM</b>	10000
3	G.MON.TAP-1 <b>MONTAJ TAPASI 12 mm / MONTAGE PLUG 12 mm / МОНТАЖНАЯ ЗАГЛУШКА 12MM</b>	30000
4	G.KKT-01 <b>KANAT KALDIRMA TAKOZU / SASH GUIDING SUPPORT / ПРИПОДНИМАТЕЛЬ СТВОРКИ</b>	10000



NO	PLASTİK MİKROVENTİLASYON PLASTIC MICROVENTILATION МИКРОВЕНТИЛЯЦИЯ ПЛАСТИКОВАЯ	RENK COLOR ЦВЕТ	
PMV 212-1		BEYAZ / WHITE / БЕЛЫЙ RAL 9016	100
PMV 212-2		ALTINMEŞE / GOLDEN OAK / СВЕТЛОКОРИЧНЕВЫЙ RAL 8003	100
PMV 212-3		KOYU KAHVE / DARK BROWN / ТЁМНОКОРИЧНЕВЫЙ RAL 8019	100
PMV 212-RA		ÖZEL RENK / PRIVATE COLOR / ЦВЕТ НА ЗАКАЗ	100

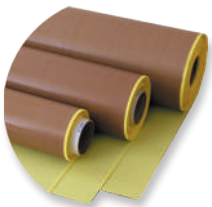

NO	TEFLON TEFLON ТЕФЛОН	
TEF.YAP.01	YARIŞKANLI TEFLON ( 13 MİKRON ) / SEALED TEFLON ( 13 MİKRON ) / ТЕФЛОН (САМОКЛЕЮЩИЙСЯ) ( 13 MİKRON )	50 m <sup>2</sup>

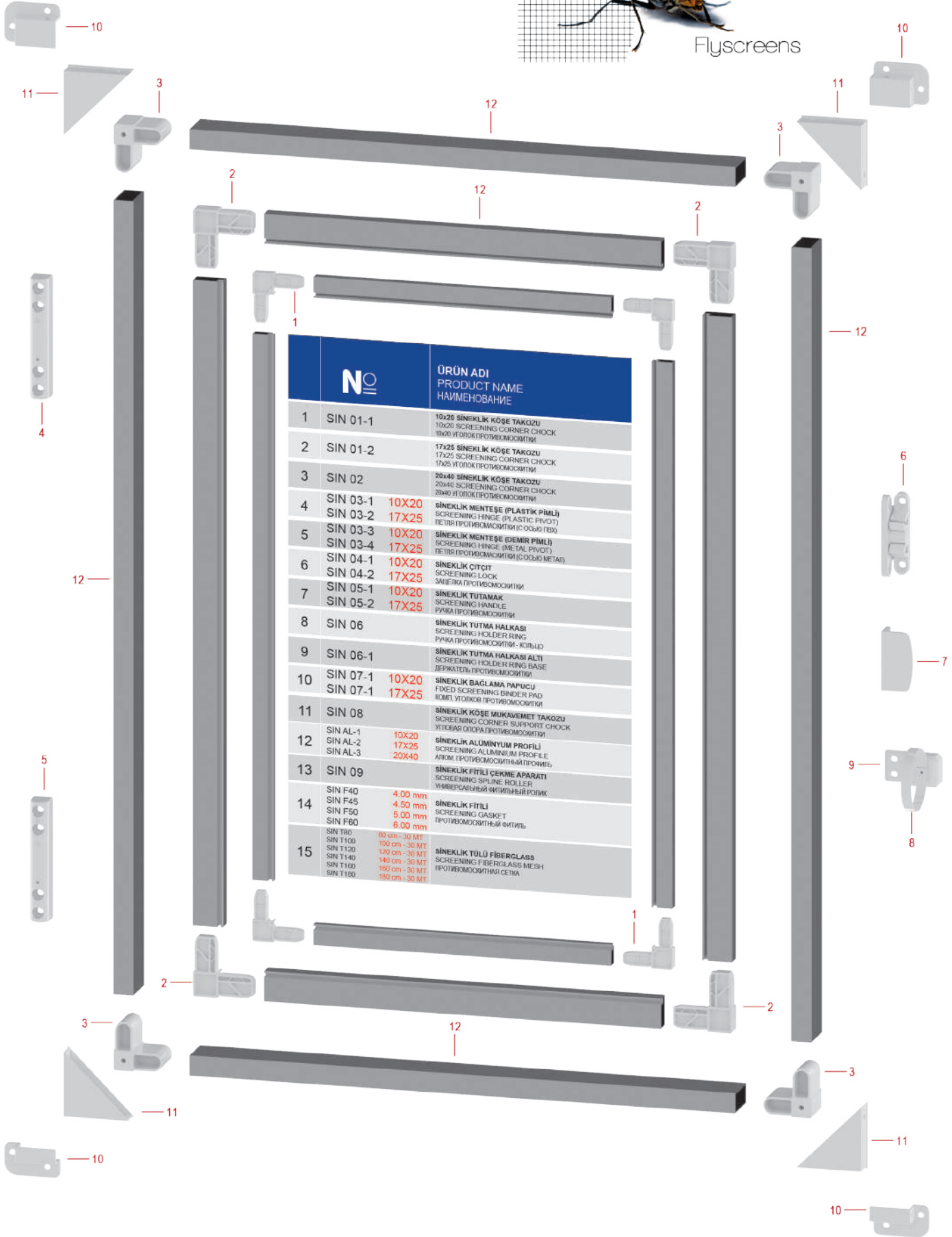

NO	ÜRÜN ADI PRODUCT NAME НАИМЕНОВАНИЕ
1	SIN 01-1 10x20 SİNEKLİK KÖŞE TAKOZU 10x20 SCREENING CORNER CHOCK 10x20 УГОЛОК ПРОТИВОМОЩНОСТИ
2	SIN 01-2 17x25 SİNEKLİK KÖŞE TAKOZU 17x25 SCREENING CORNER CHOCK 17x25 УГОЛОК ПРОТИВОМОЩНОСТИ
3	SIN 02 20x40 SİNEKLİK KÖŞE TAKOZU 20x40 SCREENING CORNER CHOCK 20x40 УГОЛОК ПРОТИВОМОЩНОСТИ
4	SIN 03-1 10X20 SİNEKLİK MENTEŞE (PLASTİK PİMLİ) SCREENING HINGE (PLASTIC PIVOT) ПЕТЛЯ ПРОТИВОМОЩНОСТИ (СО СЪЕД. ПИВ.)
5	SIN 03-3 10X20 SİNEKLİK MENTEŞE (DEMİR PİMLİ) SCREENING HINGE (METAL PIVOT) ПЕТЛЯ ПРОТИВОМОЩНОСТИ (СО СЪЕД. МЕТ.)
6	SIN 04-1 10X20 SİNEKLİK SİTÇİT SCREENING LOCK ЗАЩЕЛКА ПРОТИВОМОЩНОСТИ
7	SIN 05-1 10X20 SİNEKLİK TUTANAK SCREENING HANDLE РУЧКА ПРОТИВОМОЩНОСТИ
8	SIN 06 SİNEKLİK TUTMA HALKASI SCREENING HOLDER RING РУЧКА ПРОТИВОМОЩНОСТИ - КОЛЬЦО
9	SIN 06-1 SİNEKLİK TUTMA HALKASI ALTI SCREENING HOLDER RING BASE ДЕРЖАТЕЛЬ ПРОТИВОМОЩНОСТИ
10	SIN 07-1 10X20 SİNEKLİK BAĞLAMA PAPUCU FIXED SCREENING ENDER PAD КОМП. УГОЛКОВ ПРОТИВОМОЩНОСТИ
11	SIN 08 SİNEKLİK KÖŞE MUKAVİMET TAKOZU SCREENING CORNER SUPPORT CHOCK УГОЛКА ОПОРА ПРОТИВОМОЩНОСТИ
12	SIN AL-1 10X20 SİNEKLİK ALÜMİNYUM PROFİLİ SCREENING ALUMINIUM PROFILE АЛЮМ. ПРОТИВОМОЩНОСТНЫЙ ПРОФИЛЬ
13	SIN 09 SİNEKLİK FİTİLİ ÇEKME APARATI SCREENING SPLINE ROLLER УНИВЕРСАЛЬНЫЙ ВИНТОВЫЙ РОЛИК
14	SIN F40 4.00 mm SİNEKLİK FİTİLİ SCREENING GASKET ПРОТИВОМОЩНОСТНЫЙ ВИНТИЛ
15	SIN T80 80 cm - 30 MT SİNEKLİK TÖLÜ FİBERGLASS SCREENING FIBERGLASS MESH ПРОТИВОМОЩНОСТНАЯ СЕТКА

A **NO**



B **NO**



A <b>NO</b>	B <b>NO</b>	GÜVENLİK KİLİTLERİ SECURITY LOCKS ЗАМКИ БЕЗОПАСНОСТИ	RENK COLOR ЦВЕТ	
T-MND 01	T-PMD 01		BEYAZ / WHITE / БЕЛЫЙ RAL 9016	100
T-MND 02	T-PMD 02		ALTINMEŞE / GOLDEN OAK / СВЕТЛОКОРИЧНЕВЫЙ RAL 8003	100
T-MND 03	T-PMD 03		KOYU KAHVE / DARK BROWN / ТЁМНОКОРИЧНЕВЫЙ RAL 8019	100
T-MND RA	T-PMD RA		ÖZEL RENK / PRIVATE COLOR / ЦВЕТ НА ЗАКАЗ	100

A **NO**



B **NO**

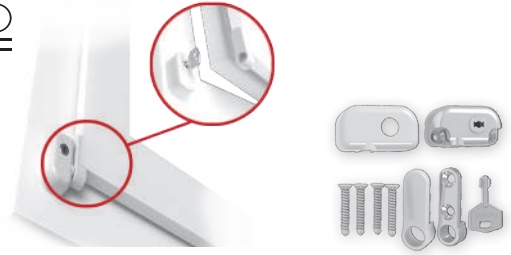



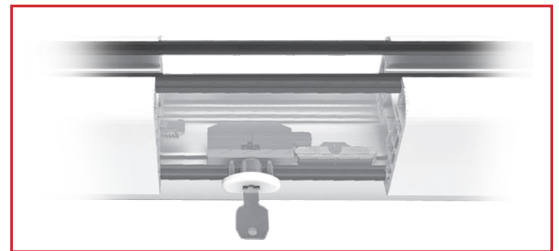
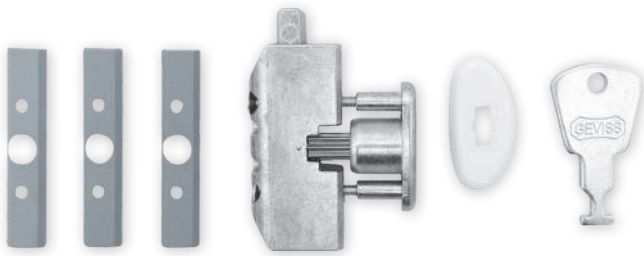

A <b>NO</b>	B <b>NO</b>	GÜVENLİK KİLİTLERİ SECURITY LOCKS ЗАМКИ БЕЗОПАСНОСТИ	RENK COLOR ЦВЕТ	
T-PKL 01	T-PTL 01		BEYAZ / WHITE / БЕЛЫЙ RAL 9016	100
T-PKL 02	T-PTL 02		ALTINMEŞE / GOLDEN OAK / СВЕТЛОКОРИЧНЕВЫЙ RAL 8003	100
T-PKL 03	T-PTL 03		KOYU KAHVE / DARK BROWN / ТЁМНОКОРИЧНЕВЫЙ RAL 8019	100
T-PKL RA	T-PTL RA		ÖZEL RENK / PRIVATE COLOR / ЦВЕТ НА ЗАКАЗ	100





<b>NO</b>	GÜVENLİK KİLİTLERİ SECURITY LOCKS ЗАМКИ БЕЗОПАСНОСТИ	RENK COLOR ЦВЕТ	
PEK 01		BEYAZ / WHITE / БЕЛЫЙ RAL 9016	100
PEK 02		ALTINMEŞE / GOLDEN OAK / СВЕТЛОКОРИЧНЕВЫЙ RAL 8003	100
PEK 03		KOYU KAHVE / DARK BROWN / ТЁМНОКОРИЧНЕВЫЙ RAL 8019	100
PEK RA		ÖZEL RENK / PRIVATE COLOR / ЦВЕТ НА ЗАКАЗ	100





ÖLÇÜ DIMENSION РАЗМЕРЫ		
3,9X13 YSBM	1.000	24.000
3,9X16 YSBM	1.000	16.000
3,9X19 YSBM	1.000	16.000
3,9X22 YSBM	1.000	14.000
3,9X25 YSBM	1.000	12.000
3,9X32 YSBM	1.000	10.000
3,9X38 YSBM	800	8.000
4,2X16 YSBM	1.000	16.000
4,2X19 YSBM	1.000	16.000
4,2X22 YSBM	1.000	10.000
4,2X25 YSBM	1.000	10.000
4,2X32 YSBM	500	6.000
4,2X38 YSBM	500	6.000
4,2X45 YSBM	500	5.000
4,8X16 YSBM	1.000	12.000
4,8X19 YSBM	1.000	10.000
4,8X22 YSBM	1.500	9.000
4,8X25 YSBM	1.000	10.000
4,8X32 YSBM	500	5.000
4,8X38 YSBM	500	5.000
4,8X50 YSBM	250	3.000
4,8X60 YSBM	250	2.500
4,8X70 YSBM	250	2.500
4,8X80 YSBM	200	2.000
4,8X100 YSBM	120	1.200

ÖLÇÜ DIMENSION РАЗМЕРЫ		
3,9X13 YHBM	1.300	31.200
3,9X16 YHBM	1.000	24.000
3,9X19 YHBM	1.250	20.000
3,9X22 YHBM	1.000	16.000
3,9X25 YHBM	1.000	14.000
3,9X32 YHBM	1.000	10.000
3,9X38 YHBM	800	8.000
4,2X16 YHBM	1.000	16.000
4,2X19 YHBM	1.000	16.000
4,2X22 YHBM	1.000	14.000
4,2X25 YHBM	1.000	12.000
4,2X32 YHBM	1.000	10.000
4,2X38 YHBM	500	6.000
4,2X45 YHBM	500	5.000
4,8X16 YHBM	1.000	2.000
4,8X19 YHBM	500	10.000
4,8X22 YHBM	1.000	1.200
4,8X25 YHBM	1.000	10.000
4,8X32 YHBM	500	6.000
4,8X38 YHBM	500	6.000
4,8X50 YHBM	500	3.000
4,8X60 YHBM	250	2.500
4,8X70 YHBM	250	2.500
4,8X80 YHBM	200	2.000
4,8X100 YHBM	120	1.200



ÖLÇÜ DIMENSION РАЗМЕРЫ		
3,9X16 ISP	1.000	24.000
3,9X19 ISP	1.250	20.000
3,9X22 ISP	1.000	16.000
3,9X25 ISP	1.000	14.000
3,9X32 ISP	1.000	10.000
3,9X38 ISP	1.000	10.000

ÖLÇÜ DIMENSION РАЗМЕРЫ		
4,2X38 ISP	500	6.000
4,2X45 ISP	500	5.000
4,8X38 ISP	500	5.000
4,8X45 ISP	500	5.000

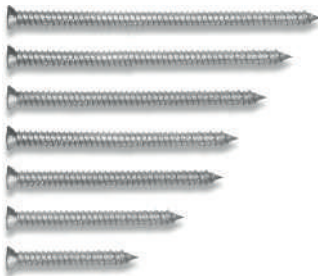

ÖLÇÜ DIMENSION РАЗМЕРЫ	
7,5X60 TDR	2.000
7,5X80 TDR	1.500
7,5X100 TDR	1.200
7,5X120 TDR	800
7,5X150 TDR	400
7,5X180 TDR	300
7,5X200 TDR	500

**ALM K.01**



**ALM K.02**



**ALM K.03**



**ALM K.04**



**ALM K.05**



**ALM K.06**



**ALM K.07**



**ALM K.08**



**ALM K.09**

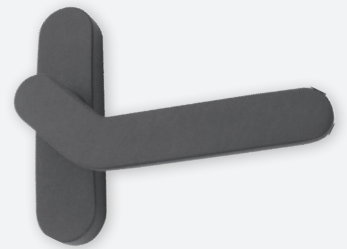

**ALM K.10**



**ALM K.11**



**ALM K.12**



**ALM K.13**



**ALM K.14**



**ALM K.15**





**ALM K.16**



**ALM K.17**



**ALM K.18**



**ALM K.19**



**ALM K.20**



**ALM K.21**



**ALM K.22**



**ALM K.23**



**ALM K.24**



**ALM K.25**



**ALM K.26**



**ALM K.27**

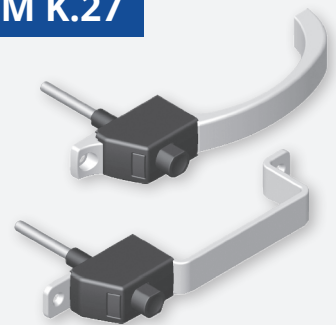

**ALM K.28**



**ALM K.29**



**ALM K.30**



**ALM K.31**



**ALM M.01**



**ALM M.02**



**ALM M.03**

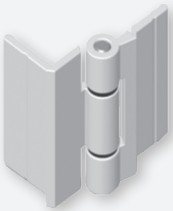

**ALM M.04**



**ALM M.05**



**ALM M.06**

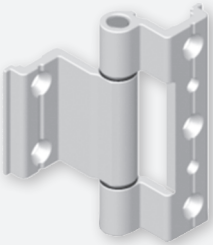

**ALM M.07**



**ALM M.08**



**ALM M.09**

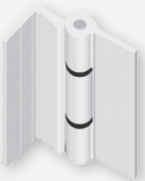

**ALM D.01**



**ALM D.02**



**ALM D.03**



**ALM V.01**



**ALM V.02**



**ALM S.01**



**ALM S.02**



**ALM S.03**



**ALM S.04**



**ALM S.05**



**ALM S.06**



**ALM B.01**

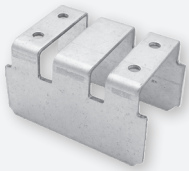

**ALM B.02**



**ALM B.03**



**ALM B.04**

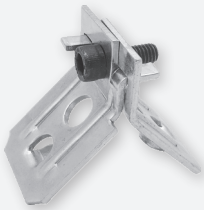

**ALM B.05**



**ALM B.06**



**ALM B.07**



**ALM B.08**



**ALM B.09**



A	Kol Eksen	7.5 - 15.5 mm
B	Kanat Bini Yük.	18 - 20 - 22 mm
C	Conta Baskı Yük.	3 - 3.5 mm
D	Kilitleme Eksen	9 - 13 mm
E	Çalışma Boşluğu	12 mm

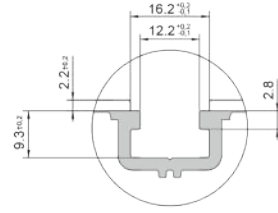
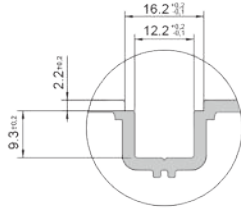
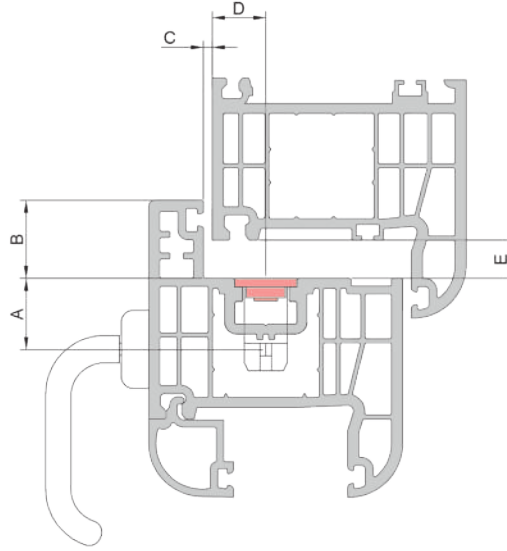

- \* Kasa kanat arasındaki çalışma boşluğu 12 mm olmalıdır. Aksi takdirde sistemin çalışmasında problemler meydana gelebilir.
- \* The working gap between the frame and sash must be 12 mm. Otherwise the system may not work properly.
- \* Рабочий зазор между рамкой и створкой должен быть 12мм. В противном случае в работе системы могут появиться проблемы.

PENCERE VE KAPI DİYAGRAMI / WINDOWS AND DOORS DIAGRAM / ДИАГРАММА ОКНА И ДВЕРИ

Maksimum Kanat Ağırlığı: 100 kg

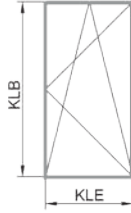

1mm/m<sup>2</sup> Cam Kalınlığı = 2,5 kg  
CA = Cam Ağırlığı

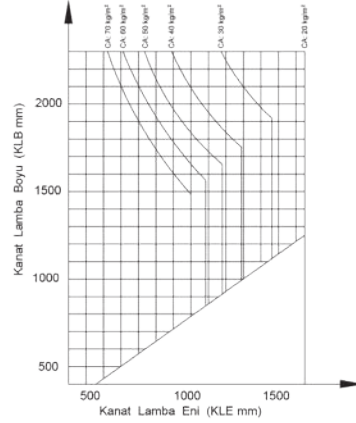

Maksimum Kanat Ağırlığı: 130 kg

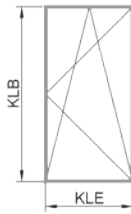

1mm/m<sup>2</sup> Cam Kalınlığı = 2,5 kg  
CA = Cam Ağırlığı

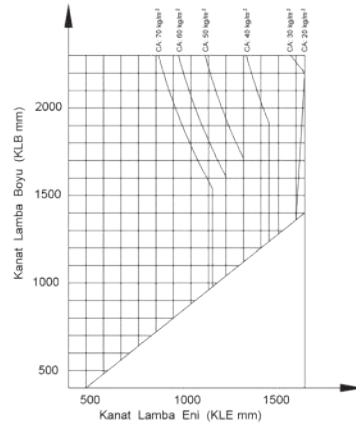

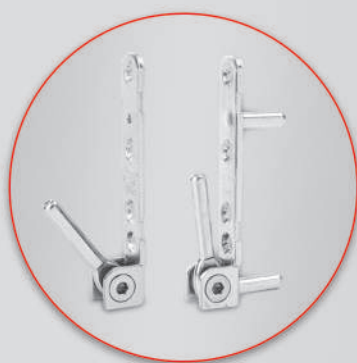
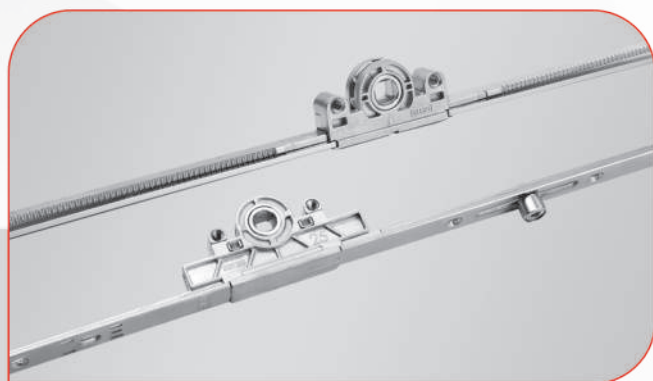



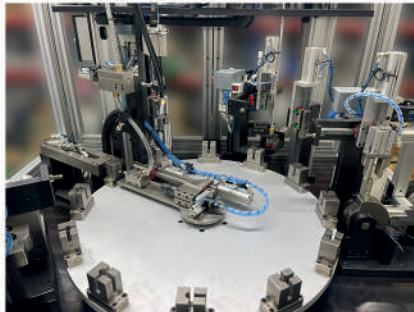
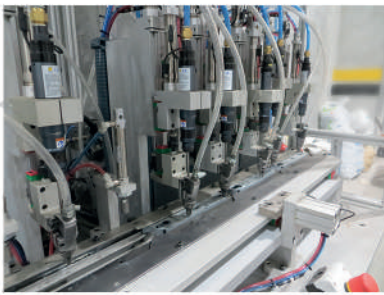
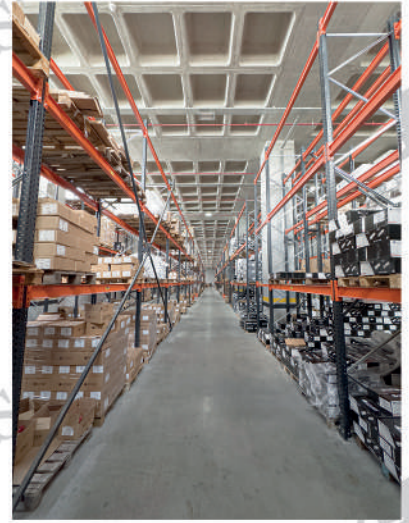

# INNOVATIVE SOLUTIONS

COMFORTABLE LIVING  
quality products  
GENIUS IDEAS  
FINE DETAILS  
**FOR MORE  
AND  
BETTER**  
STRONG TEAM  
safe usage  
DURABLE GOODS



INNOVATIVE HARDWARE FOR WINDOW & DOOR

**HİMSAN PENCERE VE KAPI SİSTEMLERİ ANONİM ŞİRKETİ**  
Ömerli Mah. Ragıp Cad. No:28/2 Arnavutköy - İSTANBUL / TÜRKİYE  
Tel: + 90 (212) 595 48 00 (Pbx)  
E-mail: [info@geviss.com.tr](mailto:info@geviss.com.tr) Web: [www.geviss.com.tr](http://www.geviss.com.tr)



copyright by GEVISS 2024